



## Check Valves

700, 700H, 701, 700A, CVL Series



### Feature

- Pressure rating up to 6000psig(413bar) @ 70°F(21°C) - 700H, CVL Series  
3000psig(206bar) @ 70°F(21°C) - 700, 701, 700A Series
- Temperature rating up to 375°F(191°C) with FKM seal  
900°F(482°C) - CVL Series
- Suitable for gas and liquid
- SS316 body material as standard
- 100% factory tested for cracking and reseal



# 700 Series

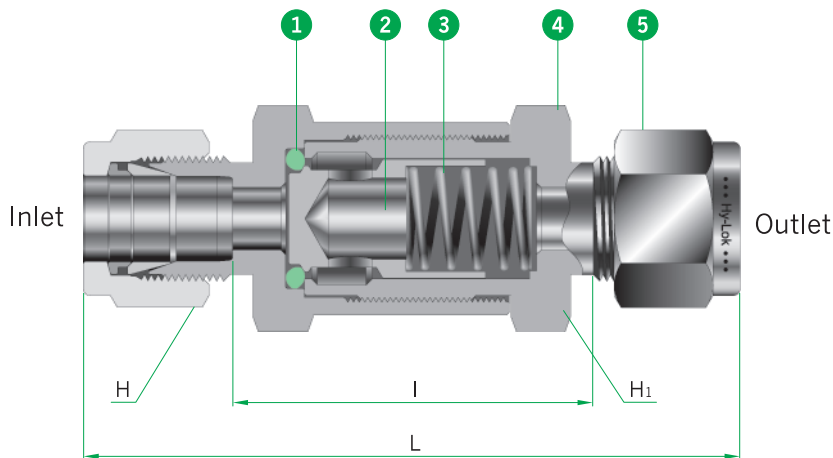

- 1 O-Ring**
  - provides leak tight shut - off.
- 2 Back Stopped Poppet**
  - prevents the spring from being overstressed.
- 3 Variety of Springs**
  - are available for the cracking pressure in the range from 1/3 psig to 100psig.
- 4 Wide Range of Body Sizes**
  - allow Cv choices from 0.16 to 8.0
- 5 Variety of End Connections**
  - include Hy-Lok tube fittings, male/female NPT tapered threads, male/female ISO tapered threads.

## Technical Data

Series	CV1	CV2 CV3 CV4	CV5 CV6
Max. Working Pressure @ 70°F (21°C)	3000 psig (206barg)		2000 psig (137barg)
Operating Temperature Range	FKM : -10°F to 375°F (-23°C to 191°C) NBR : -10°F to 250°F (-23°C to 121°C)		
Nominal Cracking Pressure	1/3, 1, 3, 10, 25, 100 psig		1/3, 1, 3, 10, 25 psig

## Table of Dimensions

Basic Part No.	Orifice	Cv	End Connections		Dimensions				
			Inlet	Outlet	L	I	H (Nut Hex)	H1 (Body Hex)	
CV1	4.8	0.16	-H - 2T	1/8" Hy - Lok	1/8" Hy - Lok	55.6	30.2	11.1	15.9
			-M - 2N	1/8" Male NPT	1/8" Male NPT	44.4	-	-	
			-F - 2N	1/8" Female NPT	1/8" Female NPT	46.6	-	-	
			-H - 4T	1/4" Hy - Lok	1/4" Hy - Lok	60.0	29.5	14.3	
		0.47	-H - 6M	6mm Hy - Lok	6mm Hy - Lok	-	29.4	14.0	
			-MH-4N4T	1/4" Male NPT	1/4" Hy - Lok	56.4	-	14.3	
			-M - 4N	1/4" Male NPT	1/4" Male NPT	53.4	-	-	
			-F - 4N	1/4" Female NPT	1/4" Female NPT	54.6	-	-	
CV2	7.1	1.48	-H - 6T	3/8" Hy - Lok	3/8" Hy - Lok	74.8	41.3	17.5	22.2
			-H - 10M	10mm Hy - Lok	10mm Hy - Lok	-	40.4	19.0	
			-M - 6N	3/8" Male NPT	3/8" Male NPT	64.6	-	-	
CV3	10.0	1.70	-F - 6N	3/8" Female NPT	3/8" Female NPT	63.8	-	-	22.2
			-H - 8T	1/2" Hy - Lok	1/2" Hy - Lok	80.2	34.5	22.2	
			-H - 12M	12mm Hy - Lok	12mm Hy - Lok	-	34.6	22.0	
			-M - 8N	1/2" Male NPT	1/2" Male NPT	74.4	-	-	
CV4	13.5	2.60	-F - 8N	1/2" Female NPT	1/2" Female NPT	84.7	-	-	28.6
			-H - 10T	5/8" Hy - Lok	5/8" Hy - Lok	91.8	48.1	25.4	
CV5	16.0	5.20	-H - 12T	3/4" Hy - Lok	3/4" Hy - Lok	110.7	61.9	28.6	31.8
			-M - 12N	3/4" Male NPT	3/4" Male NPT	105.3	-	-	
			-F - 12N	3/4" Female NPT	3/4" Female NPT	103.0	-	-	
CV6	18.0	8.00	-H - 16T	1" Hy - Lok	1" Hy - Lok	121.2	58.7	38.1	34.9
			-M - 16N	1" Male NPT	1" Male NPT	116.2	-	-	
			-F - 16N	1" Female NPT	1" Female NPT	111.4	-	-	

All dimensions in millimeters. Dimensions shown with Hy - Lok nuts in finger - tight position, where applicable.

## Materials of Construction

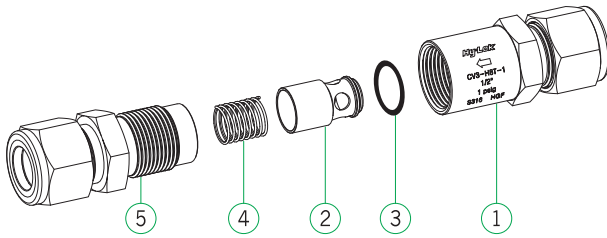

No.	Component	Valve Body Materials	
		Material Grade / ASTM Specification	
1	Inlet Body	SS316 / A479 or A276	BRASS / B16
2	Poppet	SS316 / A479 or A276	BRASS / B16
3	O-Ring	FKM	
4	Spring	SS302	
5	Outlet Body	SS316 / A479 or A276	BRASS / B16

Molybdenum dry film lubricant is used for outer body made of 316SS  
Silicone based lubricant is used for poppet.

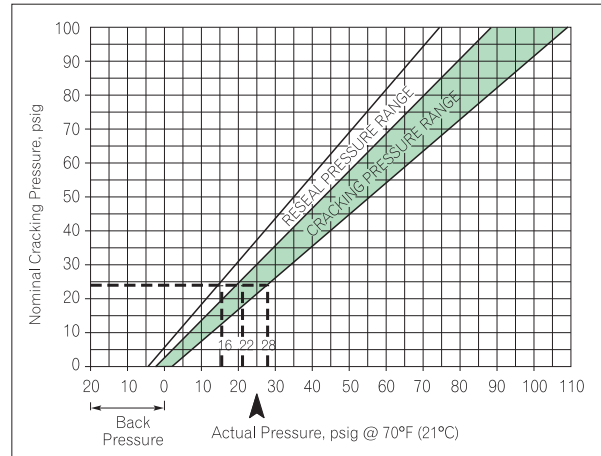

### Cracking and Reseal Pressure

- From the graph, the actual cracking pressure of nominal 25psi is shown to range between 22psi to 28psi, and the reseal pressure 16psi to 22psi.

**Back pressure** may be required to reseal the valves with nominal cracking pressure of 5psi or lower.

- Cracking pressure : The upstream pressure at which the first indication of flow occurs.
- Reseal pressure : The upstream pressure at which there is no indication of flow.

## Flow Rate at 70°F (20°C)

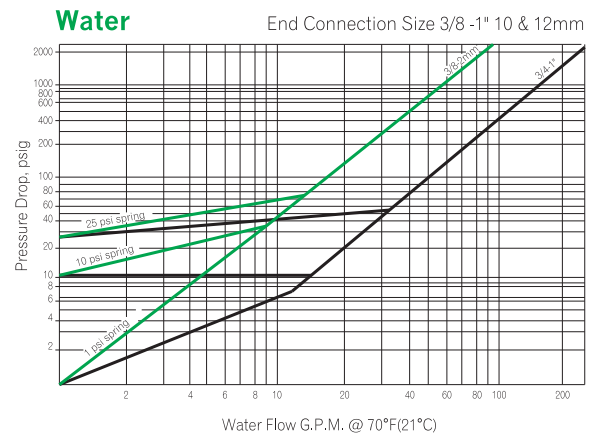
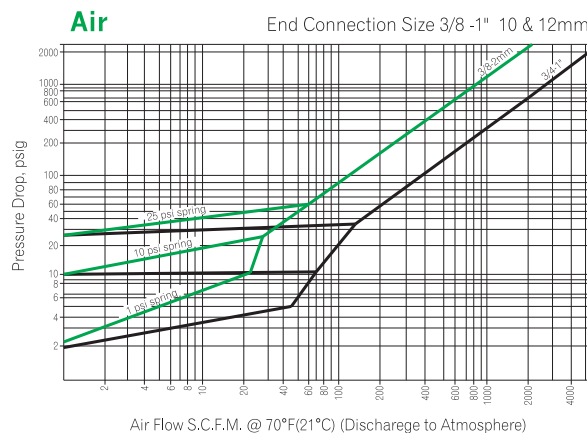
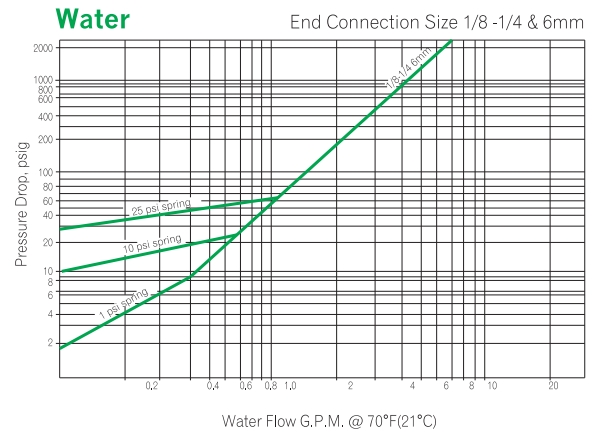
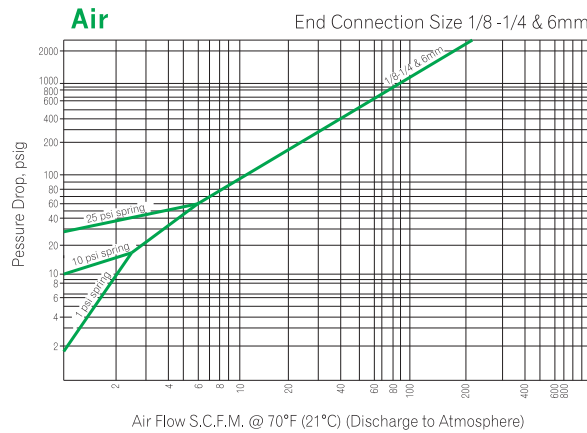

# 700H Series

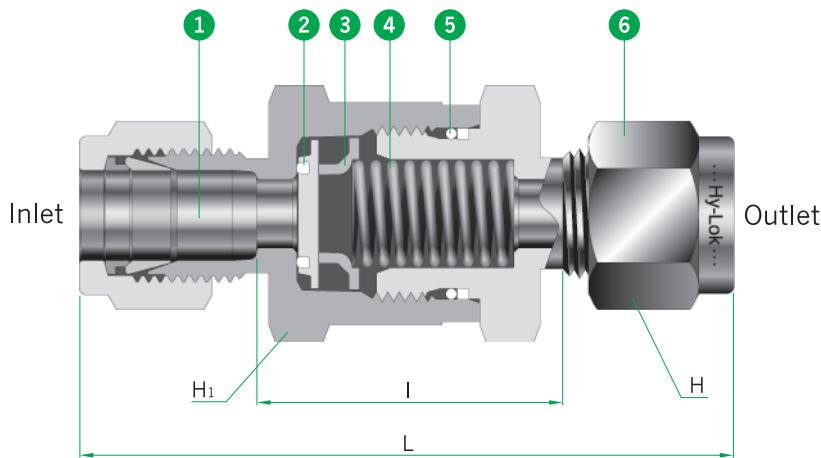

- 1 Orifice**
  - is max. flow design for min. pressure drop.
  - include flow dia from 4.8mm to 15.0mm
- 2 Poppet**
  - provides leak tight shut-off with elastomer seal
- 3 Poppet Stopper**
  - provides minimizes spring stress.
- 4 Springs**
  - are available for the cracking pressure in the range from 1/3psig to 25psig
- 5 O-ring and Back Up Rings**
  - are halves for ensures closure to the rated pressure
- 6 Variety of End Connection**
  - include Hy-Lok tube fittings, male and female NPT, ISO tapered threads, ZCO ends and Matal Gasket Seal ends.

## Technical Data

Series	CVH1	CVH2	CVH3
Max. Working Pressure	6000 psig (413bar)	5000 psig (344bar)	
Operating Temperature Range	FKM : -10°F to 375°F (-23°C to 191°C) NBR : -10°F to 250°F (-23°C to 121°C)		
Nominal Cracking Pressure	1/3, 1, 5, 10, 25 psig		

## Table of Dimensions

Basic Part No.	Flow Dia.	Cv	End Connection		Pressure Rating psig (bar)			Dimensions			
			Inlet	Outlet	SS316	Carbon Steel	Alloy 400	L	I	H (Nut Hex)	H1 (Body Hex)
CVH1	4.8	0.67	1/8" Hy-Lok		6000 (413)		5000 (345)	57.7	32.1	11.1	17.5
			1/4" Hy-Lok					61.7	31.2	14.2	
			6mm Male NPT						31.1	14.0	
			1/4" Female NPT					54.1			
			1/8" Male NPT					45.5			
			1/4" Male NPT					55.1			
			1/4" Metal Gasket Seal					57.9			
			1/4" O-Ring Face Seal					50.3			
CVH2	7.8	1.80	3/8" Hy-Lok		6000 (413)		5000 (345)	69.9	36.1	17.5	25.4
			1/2" Hy-Lok					75.2	29.5	22.2	
			8mm Hy-Lok					68.6	36.2	16.0	
			10mm Hy-Lok					71.1	36.7	19.0	
			12mm Hy-Lok		75.2	29.6	22.0				
			3/8" Female NPT		5000 (345)	5300 (365)	5000 (345)	64.8			26.9
			1/2" Female NPT		4600 (316)	4900 (337)	4600 (316)	77.0			
			3/8" Male NPT		6000 (413)	5000 (345)		59.9			25.4
			1/2" Male NPT					69.3			
			1/2" Metal Gasket Seal		3500 (241)	-	-	69.3			
1/2" O-Ring Face Seal		6000 (413)	-	-	59.7						
CVH3	15.0	4.70	3/4" Hy-Lok		5000 (345)		4700 (323)	89.4	40.6	28.6	41.3
			1" Hy-Lok					98.6	36.1	38.1	
			22mm Hy-Lok					88.4	36.4	32.0	
			25mm Hy-Lok					98.6	36.0	40.0	
			3/4" Female NPT		4300 (296)			82.0			
			1" Female NPT		4100 (282)			97.3			
			3/4" Male NPT		5000 (345)		4700 (323)	83.6			
			1" Male NPT					93.2			
			3/4" Metal Gasket Seal		3000 (206)	-	-	96.0			
			3/4" O-Ring Face Seal		5000 (345)	-	-	73.7			
			1" O-Ring Face Seal								

All dimensions in millimeters, reference only subject to change. Dimensions shown with Hy-Lok nuts in finger-tight position, where applicable. (-) blank is not applicable

## Materials of Construction

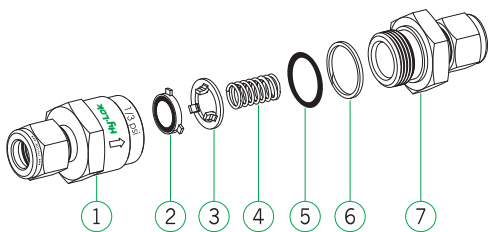

No.	Component	Valve Body Materials
		Material Grade / ASTM Specification
1	Inlet Body	SS316 / A479 or A276
2	Poppet <sup>①</sup>	FKM - bonded SS316 / A479
3	Poppet Stopper	SS316 / A240
4	Spring	SS302 / A313
5	O-Ring <sup>①</sup>	FKM
6	Back Up Ring	PTFE
7	Outlet Body <sup>②</sup>	SS316 / A479 or A276

① Fluorocarbon-Based.

② Molybdenum dry film lubricant on thread.

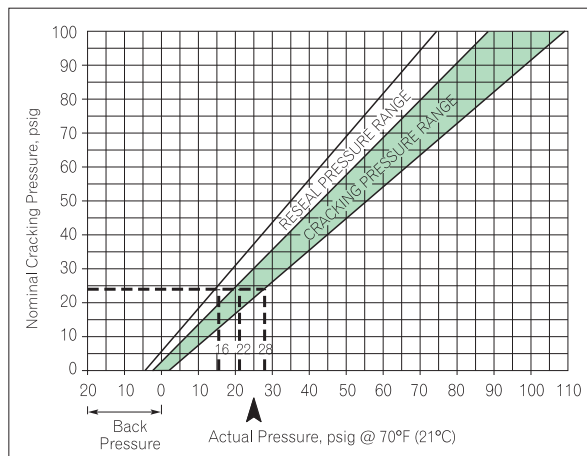

### Cracking and Reseal Pressure

From the graph, the actual cracking pressure of nominal 25psi is shown to range between 22psi to 28psi, and the reseal pressure 16psi to 22psi.

**Back pressure** may be required to reseal the valves with nominal cracking pressure of 5psi or lower.

1. Cracking pressure : The upstream pressure at which the first indication of flow occurs.
2. Reseal pressure : The upstream pressure at which there is no indication of flow.

## Flow Rate at 70°F (20°C)

### Air (CVH1)

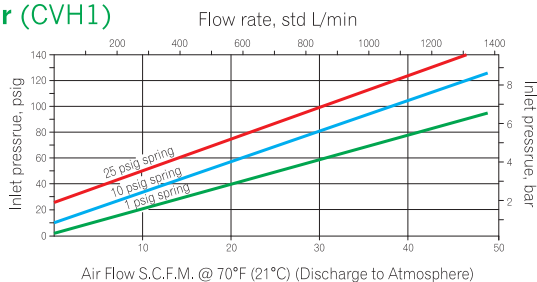

### Water (CVH1)

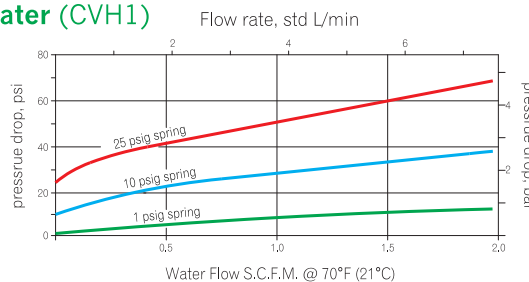

### Air (CVH2)

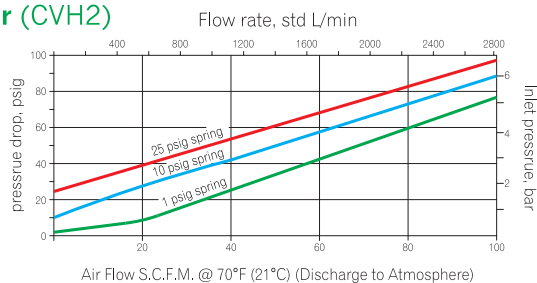

### Water (CVH2)

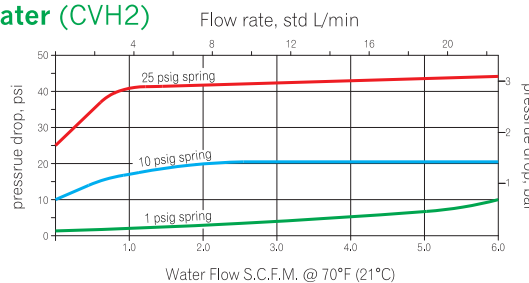

### Air (CVH3)

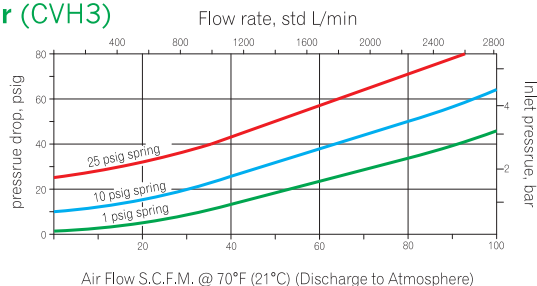

### Water (CVH3)

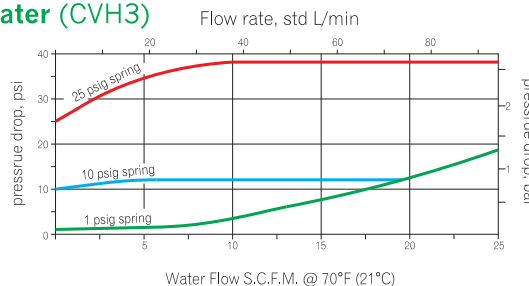

# 701, 700A Series

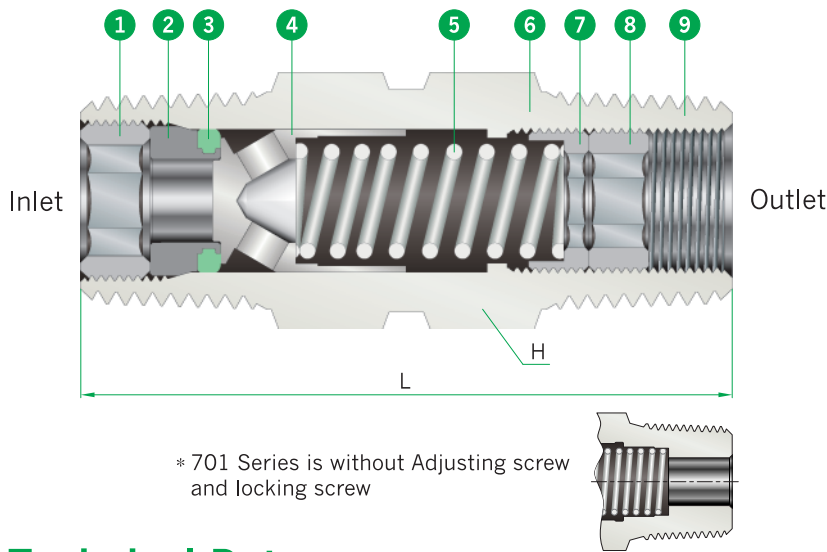

- 1 Stop nut**
  - helps to contain the insert.
- 2 Insert**
  - prevents blow-out of o-ring.
- 3 O-Ring**
  - provides leak tight shut-off
- 4 Back Stopped Poppet**
  - prevents the spring from being over stressed
- 5 Spring**
  - a wide range of adjustable springs are available for the cracking pressure in the range from 3psig to 600psig.
- 6 One-piece Body**
  - made from bar stock
- 7 Adjusting screw (700A Series Only)**
  - sets desired cracking pressure
- 8 Locking screw (700A Series Only)**
  - maintains setting.
- 9 End Connections**
  - Male & Female ISO tapered threads, Male & Female NPT.

## Technical Data

Series	701	700A
Max. Working Pressure		3000 psig (206bar)
Operating Temperature Range	FKM : -10°F to 375°F (-23°C to 191°C) NBR : -10°F to 250°F (-23°C to 121°C)	
Nominal Cracking Pressure	1/3, 1, 3, 5, 10, 25 psig	3 to 50 psig 50 to 150 psig 150 to 350 psig 350 to 600 psig

## Table of Dimensions

Basic Part No.	Flow Dia.	End Connections		Dimensions				
		Inlet	Outlet	L		H		
				mm	in.	mm	in.	
Stationary Cracking Pressure								
CV (701 Series)	-M4N	4.8	1/4" Male NPT	1/4" Male NPT	41.1	1.62	14.2	9/16
	-M8N	10.0	1/2" Male NPT	1/2" Male NPT	57.9	2.28	22.2	7/8
	-F4N	4.8	1/4" Female NPT	1/4" Female NPT	61.2	2.41	19.1	3/4
	-F8N	10.0	1/2" Female NPT	1/2" Female NPT	94.2	3.71	26.9	1 1/16
	-FM4N	4.8	1/4" Female NPT	1/4" Male NPT	58.2	2.29	19.1	3/4
	-MF4N		1/4" Male NPT	1/4" Female NPT	44.4	1.75		
-MF8N	10.0	1/2" Male NPT	1/2" Female NPT	71.9	2.83	26.9	1 1/16	
Adjustable Cracking Pressure								
CVA (700A Series)	-M4N	4.8	1/4" Male NPT	1/4" Male NPT	41.1	1.62	14.2	9/16
	-M4R		1/4" Male ISO Tapered	1/4" Male ISO Tapered				
	-F4N		1/4" Female NPT	1/4" Female NPT				
	-M8N	10.0	1/2" Male NPT	1/2" Male NPT	65.0	2.55	22.2	7/8
	-M8R		1/2" Male ISO Tapered	1/2" Male ISO Tapered				

All dimensions in millimeters. Dimensions are for reference only, subject to change.

## Cracking Pressure Adjustment

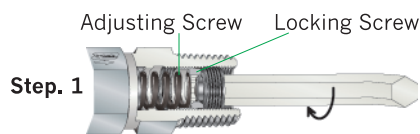

**Step. 1** Insert the hex wrench into the lock screw. Loosen the lock screw by rotating the hex wrench 2 to 3 full turns in the counterclockwise direction.



**Step. 2** After loosening the lock screw, align the hex wrench as it will enter into the adjustment screw. To establish the desired cracking pressure, rotate the hex wrench in a clockwise direction to increase the cracking pressure or rotate the hex wrench in a counterclockwise direction to decrease the cracking pressure.



**Step. 3** After adjusting the adjustment screw to reach the desired cracking pressure, withdraw the hex wrench from the adjustment screw. Tighten the lock screw against the adjustment screw firmly by rotating the hex wrench in a clockwise direction.

After testing for the desired cracking pressure, if additional adjusting is required, repeat steps 1 through 3.

## Materials of Construction

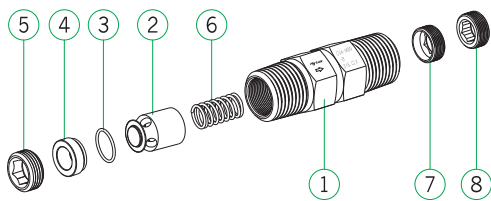

No.	Component	Valve Body Materials		
		316 Stainless Steel	Brass	
			1/4"	1/2"
Material Grade / ASTM Specification				
1	Body <sup>①</sup>	SS316 / A479 or A276	Brass360 / B16	
2	Poppet	SS316 / A479 or A276	Brass360 / B16	
3	O-ring <sup>②</sup>	FKM	NBR	
4	Insert	SS316 / A479 or A276	Brass360 / B16	
5	Stop nut	SS316 / A479 or A276	Brass360 / B16	
6	Spring	SS302 / A313		
7	Adjusting screw <sup>③†</sup>	SS316 / A479 or A276	SS316 / A479 or A276	Brass360 <sup>③</sup> / B16
8	Locking screw <sup>③†</sup>	SS316 / A479 or A276	SS316 / A479 or A276	Brass360 <sup>③</sup> / B16

① Silicone-based lubricant.  
 ② Molybdenum disulfide-based dry film lubricant.  
 ③ Adjusting screw in brass valve with "C" or "D" (150~600 psig) spring is 316SS.  
 † 700A Series only.

## Cracking and Reseal Pressure at 70°F (20°C)

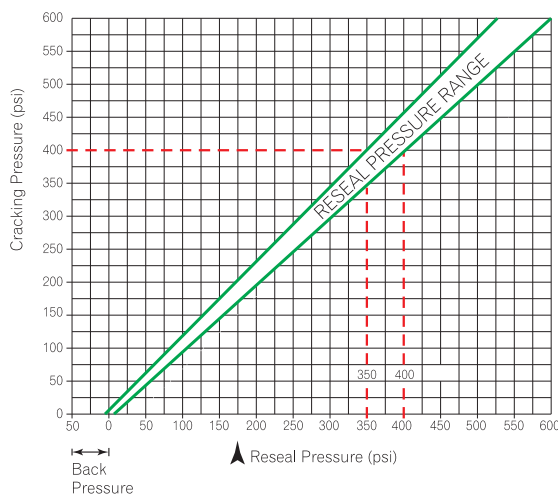

Example : For a valve set to crack at 400 psi, the minimum reseal pressure would be 350psi.

**!** Valves that are not actuated for a period of time may crack initially at higher than subsequent cracking pressure.

701, 700A series check valves set to crack at 20psi or lower may require back pressure to reseal bubble-tight.

1. Cracking pressure : The upstream pressure at which the first indication of flow occurs.
2. Reseal pressure : The upstream pressure at which there is no indication of flow.

## Flow Rate at 70°F (20°C)

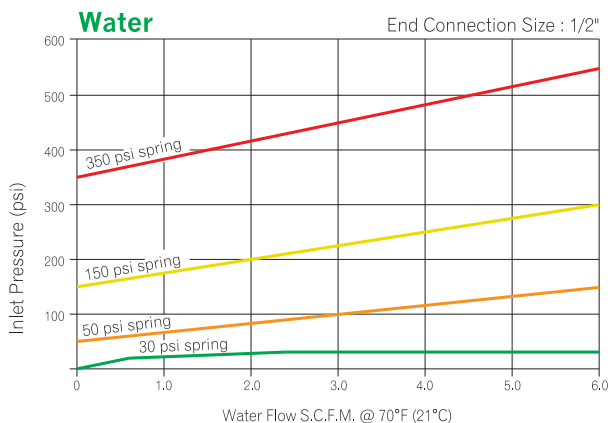
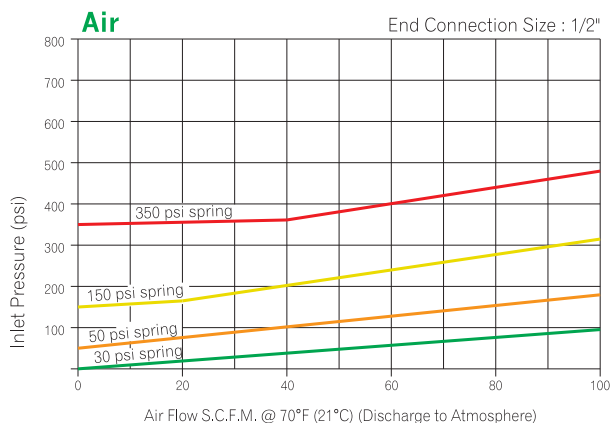
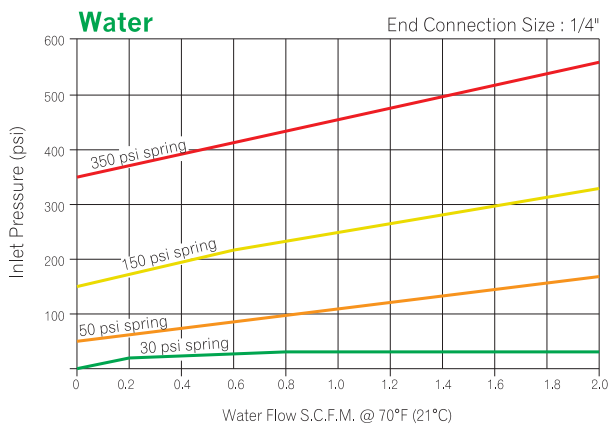
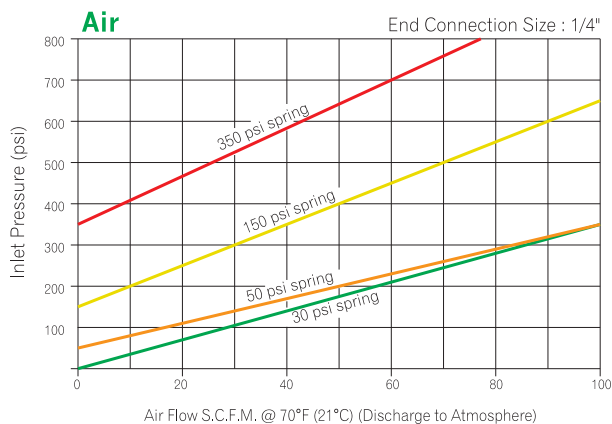

# Check Valves

## Cleaning

- Each valve is cleaned and packaged according to the company standard cleaning procedures.

## Testing

- Each valve is tested with nitrogen for cracking and reseal performance.
- Optional tests are available upon request.

## O - Ring Materials

- Available are various O - ring materials, whose temperature ratings are shown below.

Material	Temperature Rating
FKM	-23°C to 191°C (-10°F to 375°F)
NBR	-23°C to 121°C (-10°F to 250°F)
Kalrez	-23°C to 315°C (-10°F to 600°F)
PTFE	-46°C to 232°C (-50°F to 450°F)
Neoprene	-40°C to 121°C (-40°F to 250°F)
Ethylene Propylene	-46°C to 149°C (-50°F to 300°F)

\* High back pressure is required for PTFE to seal leak - tight.

## Ordering Information

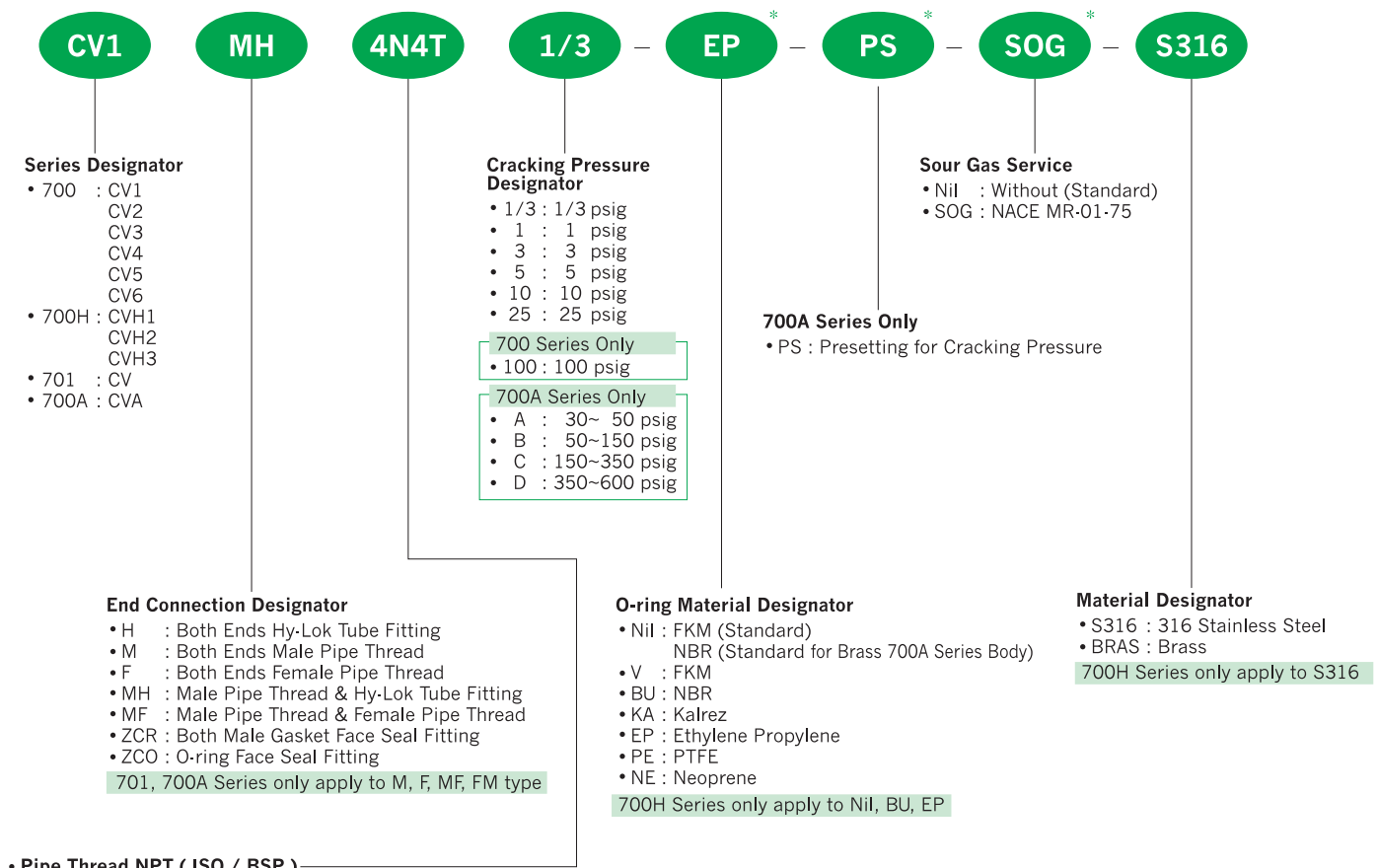

### • Pipe Thread NPT ( ISO / BSP )

Thread(NPS)	1/8	1/4	3/8	1/2	3/4	1
Designator	2N(R)	4N(R)	6N(R)	8N(R)	12N(R)	16N(R)

### • Tube

Fractional Tube	O.D.	1/8"	1/4"	3/8"	1/2"	3/4"	1"
	Designator	2T	4T	6T	8T	12T	16T
Metric Tube	O.D.	3mm	6mm	10mm	12mm	20mm	25mm
	Designator	3M	6M	10M	12M	20M	25M

**Note** \* : No designator is required for standard.  
e.g CVH1H - 4T - 1/3 - S316

**701, 700A Series only apply to 1/2" & 1/4"**

## SAFETY in VALVE SELECTION

Proper installation, materials compatibility, operation and maintenance of these valves are the responsibility of the user. The total system design must be taken into consideration to ensure optimal performance and safety.