



[www.hy-lok.com](http://www.hy-lok.com)

Catalog No. H-310PF  
May 2016

# Forged Fittings

Socket Welding and Threaded - ASME B16.11



**HY-LOK CORPORATION**

©2001, 2013, 2016 HY-LOK CORPORATION All rights reserved



# Forged Fittings

## Information

4-7

90° Elbow  
**SWLA**



8-10

Cap  
**SWCA**



11-13

Tee  
**STA**



19-21

Tee  
**SWTA**



8-10

Boss Type A  
**SWBA**



14

Boss Type R  
**SWBR**



45° Elbow  
**SLB**



19-21

45° Elbow  
**SWLB**

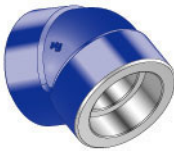

8-10

Reducing Insert  
**SWRM**



15-16

Cross  
**SXA**



19-21

Cross  
**SWXA**



8-10

Union  
**SWUR**

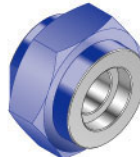

17

Street Elbows  
**SLC**



22-23

Full Coupling  
**SWFC**



11-13

Socketlets  
**SWOL**



18

Full Coupling  
**SFC**



24-25

Half Coupling  
**SWHC**



11-13

90° Elbow  
**SLA**



19-21

Half Coupling  
**SHC**



24-25

Cap  
**SCA**



24-25

Union  
**SUR**



28

Hex Reducing Nipple  
**H-SNR**

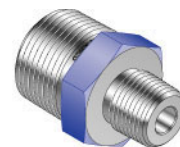

32

Boss Type A  
**SBA**



Boss Type R  
**SBR**



26

Nipple Outlet  
**SNOL**



29

Hollow Hex Plug  
**H-SPA**



33

Square Head Plug  
**H-SPD**



27

Plain Nipple Outlet  
**SPOL**



29

Hex Head Plug  
**H-SPC**



33

Hex Head Plug  
**H-SPB**



27

Swaged Nipple



30

Blanking Plugs with ED-Ring for Ports  
**DVSTI-GED/MED**



34

Round Head Plug  
**H-SPR**



27

Thredolets  
**SOL**



31

Blanking Plugs with O-Ring for Ports  
**DVSTI**



34

Hex Head Bushing  
**H-SHB**



27

Hex Nipple  
**H-SNA**



32

Seal & Condensate Pot  
**ASCP**



35

Reference

36-39

# Forged Fittings

## Scope

This catalog covers ratings, dimensions, tolerances, marking, and material requirements for forged fittings, both socket-welding and threaded by ASME B16.11 and NORSOK Spec Class AG70, Union, Reducing Insert and Swaged Nipples by MSS Standard and BS3799 with some additions such as outlets.

## Pressure Ratings

### General

Fittings under this catalog shall be designated as class 2000, 3000, and 6000 for threaded end fittings and class 3000, 6000, and 9000 for socket-weld end fittings.

### Basic of Rating

The schedule of pipe corresponding to each class designation of fitting for rating purposes is shown in Table 1.

**Table 1. Correlation of Fittings Class With Schedule Number or Wall Designation of Pipe for Calculation of Ratings**

Class Designation of Fittings	Type of Fitting	Pipe Used for Rating Basis <sup>①</sup>	
		Schedule No.	Wall Designation
2000	Threaded	80	XS
3000		160	.
6000		.	XXS
3000	Socket welding	80	XS
6000		160	.
9000		.	XXS

**Note :** ① This table is not intended to restrict the use of pipe of thinner or thicker wall with fittings. Actually pipe may be thinner or thicker in nominal wall than that shown in Table 1. When thinner pipe is used, its strength may govern the rating. When thicker pipe is used (e.g., for mechanical strength), the strength of the fitting govern the rating.

### Nonstandard Pipe Wall Thickness

Since ASME B36.10M does not include Schedule 160 nor Double Extra Strong thickness for NPS 1/8, 1/4, and 3/8, the values in Table 2 shall be used as the nominal wall thicknesses of the pipe for rating purposes.

**Table 2. Nominal Wall Thickness of Schedule 160 and Double Extra Strong Pipe**

NPS	Schedule 160		XXS	
	mm	in.	mm	in.
1/8	3.15	0.124	4.83	0.190
1/4	3.68	0.145	6.05	0.238
3/8	4.01	0.158	6.40	0.252

### Combination End Fittings

The class for fittings made with combinations of socket-welding and threaded ends shall be based on the end configuration that has the lowest rating from Table 1

### Pressure Test Capability

Pressure testing is not required by these products, but the fittings of withstanding a hydrostatic test pressure required by applicable piping code for seamless pipe of material equivalent to the fitting forging and of the schedule or wall thickness correlated with the fitting class and end connection of Table 1.

## Size and Type

### General

NPS, followed by a dimensionless number, is the designation for nominal fitting size. NPS is related to the reference nominal diameter, DN, used in international standards. The relationship is typically as follows:

NPS	1/8	1/4	3/8	1/2	3/4	1	1 1/4	1 1/2	2	2 1/2	3	4
DN	6	8	10	15	20	25	32	40	50	65	80	100

### Reducing Fitting Size

In the case of reducing tees and crosses, the size of the largest run opening shall be given first, followed by the size of the opening at the opposite end of the run. Where the fitting is a tee, the size of the branch is given last. Where the fitting is a cross, the largest side-outlet is the third dimension given, followed by the opening opposite. The line sketches, Fig. 1, illustrate how the reducing fittings are read.

**Fig. 1 Method of Designating Outlets of Reducing Tees and Crosses**

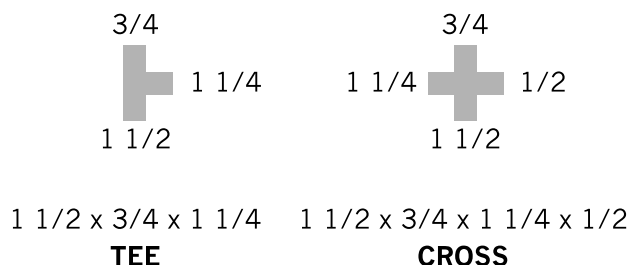

**Fitting Types**

Types of fittings covered by this catalog are shown in Table 3, by class and size range.

Description	Socket - Welding			Threaded		
	Class Designation			Class Designation		
	3000	6000	9000	2000	3000	6000
45-deg, 90-deg elbows, tees, crosses,	1/8-4	1/8-2	1/2-2	1/8-4	1/8-4	1/8-4
couplings, half-couplings, and caps	1/8-4	1/8-2	1/2-2	.	1/8-4	1/8-4
Street elbows	.	.	.	.	1/8-2	1/8-2
Square, hex, round plug, hex, and flush bushing	.	.	.	1/8-4 <sup>Ⓟ</sup>	1/8-4 <sup>Ⓟ</sup>	1/8-4
	.	.	.	1/8-4 <sup>Ⓟ</sup>	1/8-4 <sup>Ⓟ</sup>	1/8-4

**Note** :<sup>Ⓟ</sup>Plug, hex nipple and bushings are not identified by class designation. They may be used for ratings up through class 6000 designation.

**Marking**

**General**

Each fitting shall be permanently marked with the required identification by raised lettering and/or stamping, electro-etching, or vibro-tool marking on the collar portion, raised pad, or raised boss portion of the forging. Cylindrical fittings shall be marked on the O.D. or end of the fitting in a location such that the marking will not be obliterated as a result of welding installation. The marking of bushings and plugs are not required.

**Specific Marking**

The marking shall include (but is not limited to) the following.

- **Manufacturer's Name or Trademark**
- **Material Identification**
- **Class Designation**
- **Size**

**Materials**

Fittings shall be made of materials consisting of forgings, bar, seamless pipe, or seamless tubular products.

These materials shall conform to the requirements for the WP seamless construction materials of ASTM Fitting Specifications A 234, A 403, A 420, A 815, or B 366 or ASTM Forging Specifications A 105, A 182, A 350, B 462, or B 564. Tees, elbows, and crosses shall not be made from bar stock.

Super duplex stainless steel can be supply according to NORSOK M650 standard such as F53 and F51.

**Dimensions**

**General**

Unless otherwise noted, the dimensions without tolerances for socket-welding and threaded fittings given in this catalog are nominal values and subject to the designated manufacturing tolerances.

**Socket Fittings**

- **Body and Socket Wall Thickness**

The body and socket wall thickness of socket-welding fittings shall be equal to or greater than the values, G and C shown in this catalog.

- **Socket Depth**

The socket depth shall be no less than the minimum values, J, shown in this catalog.

- **Width**

The forging radius shall not reduce the width of the flat welding surface to less than the value shown in Fig. 2.

## Forged Fittings

**Fig. 2 Welding Gap and Minimum flat Dimensions for Socket - Welding Fittings**

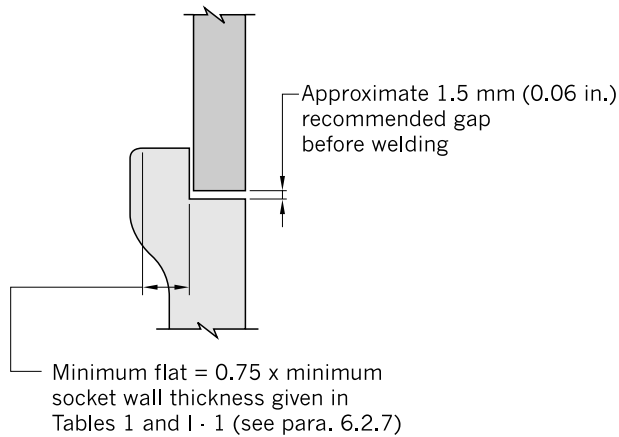

### Coincidence of Axes.

The maximum allowable variation in the alignment of the fitting bore and socket bore axes shall be 1 mm in 200 mm (0.06 in. in 1 ft).

The maximum allowable variation in alignment of threads shall be 1 mm in 200 mm (0.06 in. in 1 ft).

### Proof Testing

Proof testing for fittings made by ASME B 16.11 is not required.

### Threaded Fittings.

#### • Wall Thickness

The body or end wall thickness of threaded fittings shall be equal to or greater than the minimum values, G, as shown in this catalog.

#### • Threads

All fittings with internal and external threads shall be threaded with American National Standard Taper Pipe Threads (ASME B1.20.1).

### Collars

End collars of both socket-welding and threaded fittings shall be such that they overlap the crotch area as illustrated in the sketches in this catalog.

### Reducing Fittings

Reducing fittings shall have the same center-to-end, center-to-bottom of socket, band diameter, and outside diameters as the uniform size fitting corresponding to the largest size end connection of the reducing fitting.

### Additional Tolerances

Additional tolerances are not listed in this catalog.

### Concentricity of Bores.

The socket and fitting bores shall be concentric within a tolerance of 0.8mm (0.03 in.) for all sizes. Opposite socket bores shall be concentric within a tolerance of 1.5mm (0.06 in.) for all sizes.

## Ordering Information

### Part Number Example

1) Socket Welding

2) Threaded

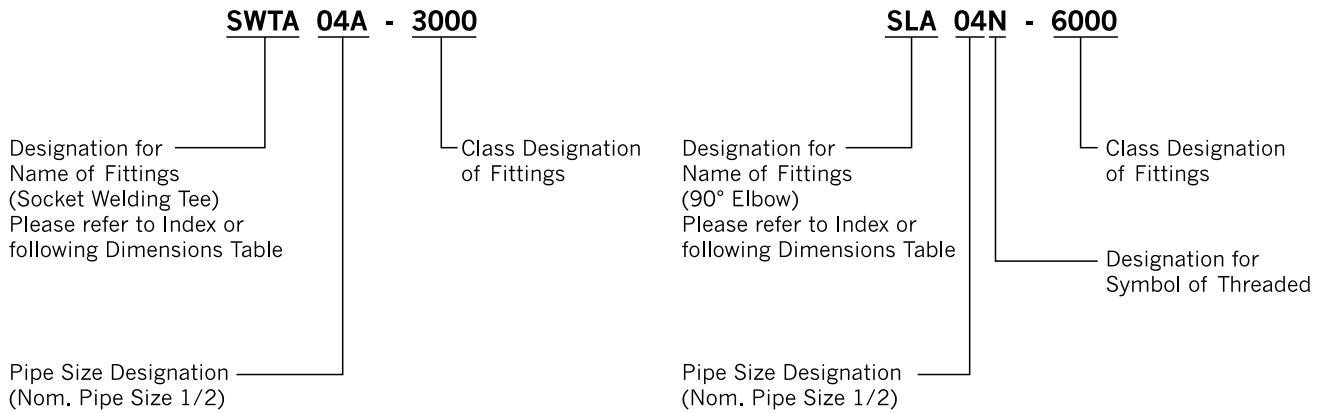

### Pipe Size Designations

Nom. Pipe Size	1/8	1/4	3/8	1/2	3/4	1	1 1/4	1 1/2	2
Designations	01A	02A	03A	04A	06A	08A	10A	12A	16A

**Note** : In case of threaded, "A" is omitted.

### Symbol of Threaded

R : Taper Pipe Thread (PT, JIS B0203, ISO 7/1)

G : Parallel Pipe Thread (PF, JIS B0202, ISO 228/1)

N : American National Standard Taper Pipe Thread (NPT, ANSI B1.20.1)



## Forged Fittings

90° Elbow  
**SWLA**

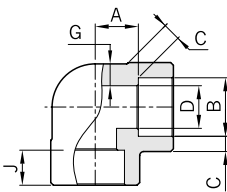

Tee  
**SWTA**

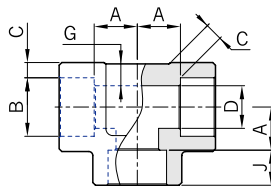

45° Elbow  
**SWLB**

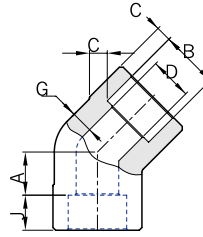
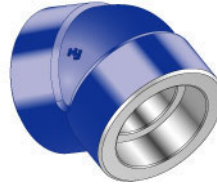

Cross  
**SWXA**

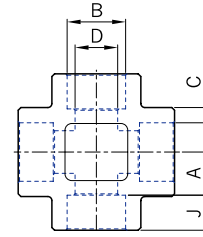
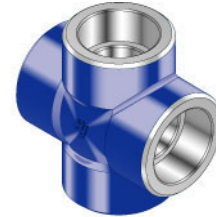

## ASME B16.11

Class Designation of Fittings	Nom. Pipe Size	DN	B Socket Bore Dia. <sup>(1)</sup>	D Bore Dia. <sup>(1)</sup>	Socket Wall Thk. C <sup>(2)</sup>	Body Wall Thk. Min. G	Depth of socket Min. J	A	A 45° Elbows
3000	1/8	6	11.2 10.8	7.6 6.1	3.18 3.18	2.41	9.5	11.0	8.0
	1/4	8	14.6 14.2	10.0 8.5	3.78 3.30	3.01	9.5	11.0	8.0
	3/8	10	18.0 17.6	13.3 11.8	4.01 3.50	3.20	9.5	13.5	8.0
	1/2	15	22.2 21.8	16.6 15.0	4.67 4.09	3.73	9.5	15.5	11.0
	3/4	20	27.6 27.2	21.7 20.2	4.90 4.27	3.91	12.5	19.0	12.5
	1	25	34.3 33.9	27.4 25.9	5.69 4.98	4.55	12.5	22.5	14.0
	1 1/4	32	43.1 42.7	35.8 34.3	6.07 5.28	4.85	12.5	27.0	17.5
	1 1/2	40	49.2 48.8	41.6 40.1	6.35 5.54	5.08	12.5	32.0	20.5
	2	50	61.7 61.2	53.3 51.7	6.93 6.04	5.54	16.0	38.0	25.5
	2 1/2	65	74.4 73.9	64.2 61.2	8.76 7.67	7.01	16.0	41.0	28.5
	3	80	90.3 89.8	79.4 76.4	9.52 8.30	7.62	16.0	57.0	32.0
	4	100	115.7 115.2	103.8 100.7	10.69 9.35	8.56	19.0	66.5	41.0

Note : (1) Upper and lower values for each size are the respective maximum and minimum dimensions.

(2) Average of socket wall thickness around periphery shall be no less than listed values.  
The minimum values are permitted in localized areas.

All dimensions are in millimeters.



90° Elbow  
**SWLA**

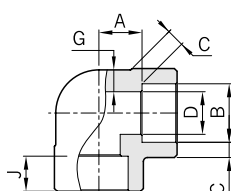

Tee  
**SWTA**

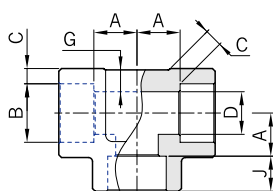

45° Elbow  
**SWLB**

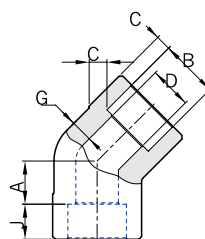
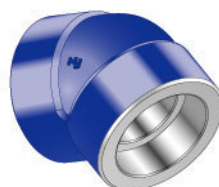

Cross  
**SWXA**

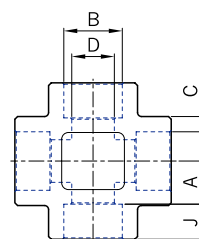

**ASME B16.11**

Class Designation of Fittings	Nom. Pipe Size	DN	B Socket Bore Dia. <sup>(1)</sup>	D Bore Dia. <sup>(1)</sup>	Socket Wall Thk. C <sup>(2)</sup>	Body Wall Thk. Min. G	Depth of socket Min. J	A	A 45° Elbows
6000	1/8	6	11.2 10.8	4.8 3.2	3.96 3.43	3.15	9.5	11.0	8.0
	1/4	8	14.6 14.2	7.1 5.6	4.60 4.01	3.68	9.5	13.5	8.0
	3/8	10	18.0 17.6	9.9 8.4	5.03 4.37	4.01	12.5	15.5	11.0
	1/2	15	22.2 21.8	12.5 11.0	5.97 5.18	4.78	9.5	19.0	12.5
	3/4	20	27.6 27.2	16.3 14.8	6.96 6.04	5.56	12.5	22.5	14.0
	1	25	34.3 33.9	21.5 19.9	7.92 6.93	6.35	12.5	27.0	17.5
	1 1/4	32	43.1 42.7	30.2 28.7	7.92 6.93	6.35	12.5	32.0	20.5
	1 1/2	40	49.2 48.8	34.7 33.2	8.92 7.80	7.14	12.5	38.0	25.5
	2	50	61.7 61.2	43.6 42.1	10.92 9.50	8.74	16.0	41.0	28.5

Note : (1) Upper and lower values for each size are the respective maximum and minimum dimensions.

(2) Average of socket wall thickness around periphery shall be no less than listed values. The minimum values are permitted in localized areas.

## Forged Fittings

90° Elbow  
**SWLA**

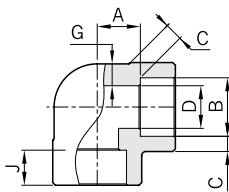

Tee  
**SWTA**

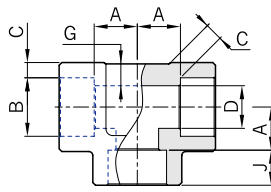
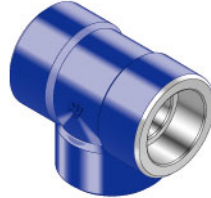

45° Elbow  
**SWLB**

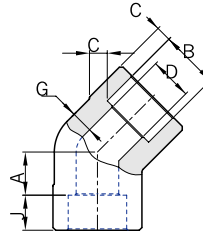
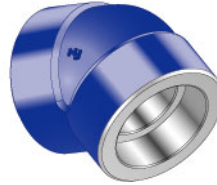

Cross  
**SWXA**

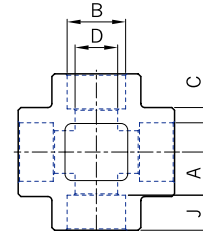
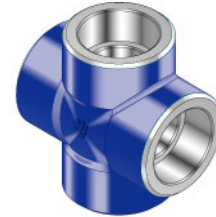

### ASME B16.11

Class Designation of Fittings	Nom. Pipe Size	DN	B Socket Bore Dia. <sup>(1)</sup>	D Bore Dia. <sup>(1)</sup>	Socket Wall Thk. C <sup>(2)</sup>	Body Wall Thk. Min. G	Depth of socket Min. J	A	A 45° Elbows
9000	1/2	15	22.2 21.8	7.2 5.6	9.35 8.18	7.47	9.5	25.5	15.5
	3/4	20	27.6 27.2	11.8 10.3	9.78 8.56	7.82	12.5	28.5	19.0
	1	25	34.3 33.9	16.0 14.4	11.38 9.96	9.09	12.5	32.0	20.5
	1 1/4	32	43.1 42.7	23.5 22.0	12.14 10.62	9.70	12.5	35.0	22.5
	1 1/2	40	49.2 48.8	28.7 27.2	12.70 11.12	10.15	12.5	38.0	25.5
	2	50	61.7 61.2	38.9 37.4	13.84 12.12	11.07	16.0	54.0	28.5

Note : (1) Upper and lower values for each size are the respective maximum and minimum dimensions.

(2) Average of socket wall thickness around periphery shall be no less than listed values.  
The minimum values are permitted in localized areas.

All dimensions are in millimeters.

Full Coupling  
**SWFC**

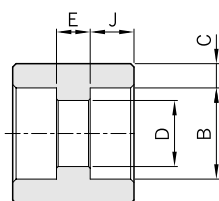

Half Coupling  
**SWHC**

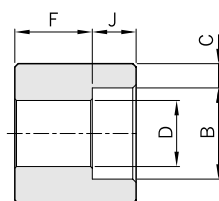

Cap  
**SWCA**

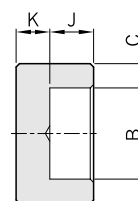

**ASME B16.11**

Class Designation of Fittings	Nom. Pipe Size	DN	B Socket Bore Dia. <sup>(1)</sup>	D Bore Dia. <sup>(1)</sup>	Socket Wall Thk. C <sup>(2)</sup>	Depth of socket Min. J	E	F	K Min.
3000	1/8	6	11.2 10.8	7.6 6.1	3.18 3.18	9.5	6.5	16.0	4.8
	1/4	8	14.6 14.2	10.0 8.5	3.78 3.30	9.5	6.5	16.0	4.8
	3/8	10	18.0 17.6	13.3 11.8	4.01 3.50	9.5	6.5	17.5	4.8
	1/2	15	22.2 21.8	16.6 15.0	4.67 4.09	9.5	9.5	22.5	6.4
	3/4	20	27.6 27.2	21.7 20.2	4.90 4.27	12.5	9.5	24.0	6.4
	1	25	34.3 33.9	27.4 25.9	5.69 4.98	12.5	12.5	28.5	9.6
	1 1/4	32	43.1 42.7	35.8 34.3	6.07 5.28	12.5	12.5	30.0	9.6
	1 1/2	40	49.2 48.8	41.6 40.1	6.35 5.54	12.5	12.5	32.0	11.2
	2	50	61.7 61.2	53.3 51.7	6.93 6.04	16.0	19.0	41.0	12.7
	2 1/2	65	74.4 73.9	64.2 61.2	8.76 7.67	16.0	19.0	43.0	15.7
	3	80	90.3 89.8	79.4 76.4	9.52 8.30	16.0	19.0	44.5	19.0
	4	100	115.7 115.2	103.8 100.7	10.69 9.35	19.0	19.0	48.0	22.4

Note : (1) Upper and lower values for each size are the respective maximum and minimum dimensions.

(2) Average of socket wall thickness around periphery shall be no less than listed values. The minimum values are permitted in localized areas.

All dimensions are in millimeters.

## Forged Fittings

### Full Coupling SWFC

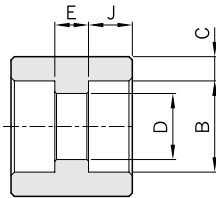

### Half Coupling SWHC

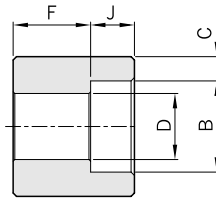

### Cap SWCA

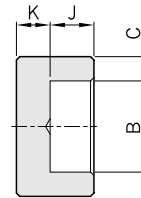

## ASME B16.11

Class Designation of Fittings	Nom. Pipe Size	DN	B Socket Bore Dia. <sup>(1)</sup>	D Bore Dia. <sup>(1)</sup>	Socket Wall Thk. C <sup>(2)</sup>	Depth of socket Min. J	E	F	K Min.
6000	1/8	6	11.2 10.8	4.8 3.2	3.96 3.43	9.5	6.5	16.0	6.4
	1/4	8	14.6 14.2	7.1 5.6	4.60 4.01	9.5	6.5	16.0	6.4
	3/8	10	18.0 17.6	9.9 8.4	5.03 4.37	12.5	6.5	17.5	6.4
	1/2	15	22.2 21.8	12.5 11.0	5.97 5.18	9.5	9.5	22.5	7.9
	3/4	20	27.6 27.2	16.3 14.8	6.96 6.04	12.5	9.5	24.0	7.9
	1	25	34.3 33.9	21.5 19.9	7.92 6.93	12.5	12.5	28.5	11.2
	1 1/4	32	43.1 42.7	30.2 28.7	7.92 6.93	12.5	12.5	30.0	11.2
	1 1/2	40	49.2 48.8	34.7 33.2	8.92 7.80	12.5	12.5	32.0	12.7
	2	50	61.7 61.2	43.6 42.1	10.92 9.50	16.0	19.0	41.0	15.7

Note : (1) Upper and lower values for each size are the respective maximum and minimum dimensions.

(2) Average of socket wall thickness around periphery shall be no less than listed values.  
The minimum values are permitted in localized areas.

All dimensions are in millimeters.

Full Coupling  
**SWFC**

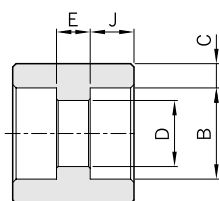

Half Coupling  
**SWHC**

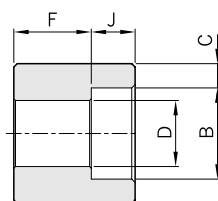

Cap  
**SWCA**

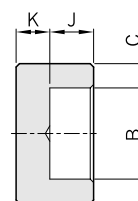

**ASME B16.11**

Class Designation of Fittings	Nom. Pipe Size	DN	B Socket Bore Dia. <sup>(1)</sup>	D Bore Dia. <sup>(1)</sup>	Socket Wall Thk. C <sup>(2)</sup>	Depth of socket Min. J	E	F	K Min.
9000	1/2	15	22.2 21.8	7.2 5.6	9.35 8.18	9.5	9.5	22.5	11.2
	3/4	20	27.6 27.2	11.8 10.3	9.78 8.56	12.5	9.5	24.0	12.7
	1	25	34.3 33.9	16.0 14.4	11.38 9.96	12.5	12.5	28.5	14.2
	1 1/4	32	43.1 42.7	23.5 22.0	12.14 10.62	12.5	12.5	30.0	14.2
	1 1/2	40	49.2 48.8	28.7 27.2	12.70 11.12	12.5	12.5	32.0	15.7
	2	50	61.7 61.2	38.9 37.4	13.84 12.12	16.0	19.0	41.0	19.0

Note : (1) Upper and lower values for each size are the respective maximum and minimum dimensions.

(2) Average of socket wall thickness around periphery shall be no less than listed values.

The minimum values are permitted in localized areas.

## Forged Fittings

### Boss Type A SWBA

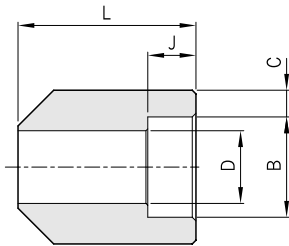
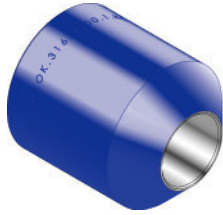

### Boss Type R SWBR

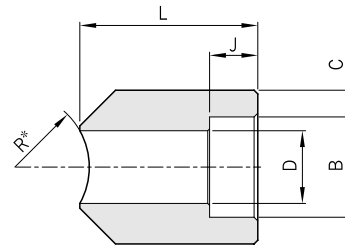

## ASME B16.11

Class Designation of Fittings	Nom. Pipe Size	B Socket Bore Dia. <sup>(1)</sup>	D Bore Dia. <sup>(1)</sup>	Socket Wall Thk. C <sup>(2)</sup>	Depth of socket Min. J	L
3000	1/4	14.6	10.0	3.78	9.5	40
		14.2	8.5	3.30		
	3/8	18.0	13.3	4.01	9.5	50
		17.6	11.8	3.50		
	1/2	22.2	16.6	4.67	9.5	50
		21.8	15.0	4.09		
	3/4	27.6	21.7	4.90	12.5	50
		27.2	20.2	4.27		
1	34.3	27.4	5.69	12.5	50	
	33.9	25.9	4.98			
1 1/4	43.1	35.8	6.07	12.5	50	
	42.7	34.3	5.28			
1 1/2	49.2	41.6	6.35	12.5	50	
	48.8	40.1	5.54			
2	61.7	53.3	6.93	16.0	60	
	61.2	51.7	6.04			
6000	1/2	22.2	12.5	5.97	9.5	50
		21.8	11.0	5.18		
	3/4	27.6	16.3	6.96	12.5	50
		27.2	14.8	6.04		
	1	34.3	21.5	7.92	12.5	50
		33.9	19.9	6.93		
	1 1/4	43.1	30.2	7.92	12.5	50
		42.7	28.7	6.93		
1 1/2	49.2	34.7	8.92	12.5	50	
	48.8	33.2	7.80			
2	61.7	43.6	10.92	16.0	50	
	61.2	42.1	9.50			

Note : \* is run pipe sizes

Example : SWBR06A-3000-R34 / S316 - 3/4" NPS CL3000 Run pipe 34.0mm O.D

(1) Upper and lower values for each size are the respective maximum and minimum dimensions.

(2) Average of socket wall thickness around periphery shall be no less than listed values.  
The minimum values are permitted in localized areas.

Dimensions are in millimeters.

Reducing Insert  
**SWRM**

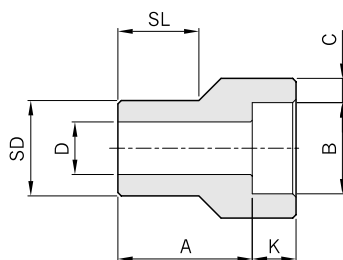

Type.1

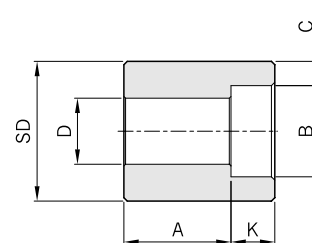

Type.2

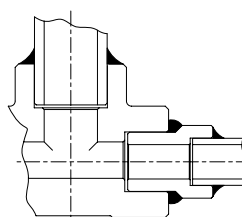

Applied View

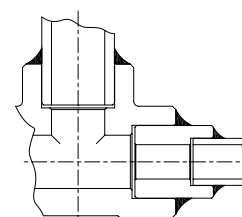

Applied View

**MSS SP-79**

Class Designation of Fittings	Nominal Pipe Size	Type	Socket		Shank Dia. SD	Laying Length A	Bore D	Wall MIN. C	Length
			Dia. B	Depth Min. K					SL
3000	3/8 x 1/4	1	14.35	10	17.15	19	9.0	3.78	14
	1/2 x 1/4	1	14.35	10	21.34	21	9.0	3.78	16
	x 3/8	1	17.78	10	21.34	21	12.5	4.01	16
	3/4 x 1/4	2	14.35	10	26.67	18	9.0	3.78	-
	x 3/8	2	17.78	10	26.67	16	12.5	4.01	-
	x 1/2	1	21.97	10	26.67	22	16.0	4.67	17
	1 x 3/8	2	17.78	10	33.40	18	12.5	4.01	-
	x 1/2	2	21.97	10	33.40	16	16.0	4.67	-
	x 3/4	1	27.31	13	33.40	24	21.0	4.90	19
	1 1/4 x 1/2	2	21.97	10	42.16	19	16.0	4.67	-
	x 3/4	2	27.31	13	42.16	18	21.0	4.90	-
	x 1	1	34.04	13	42.16	25	26.5	5.69	21
	1 1/2 x 3/4	2	27.31	13	48.26	19	21.0	4.90	-
	x 1	2	34.04	13	48.26	18	26.5	5.69	-
	x 1 1/4	1	42.80	13	48.26	28	35.0	6.07	22
	2 x 1	2	34.04	13	60.32	22	26.5	5.69	-
	x 1 1/4	2	42.80	13	60.32	21	35.0	6.07	-
	x 1 1/2	1	48.90	13	60.32	32	41.0	6.35	25

All dimensions are in millimeters.

## Forged Fittings

### Reducing Insert SWRM

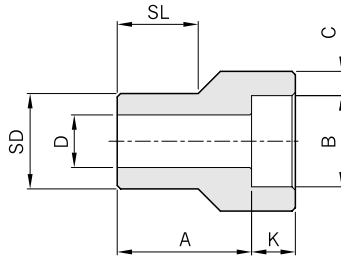

Type.1

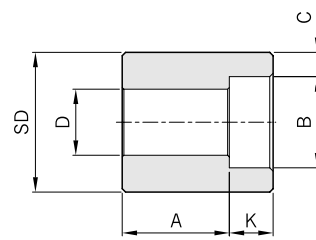

Type.2

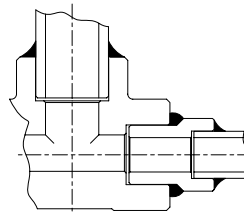

Applied View

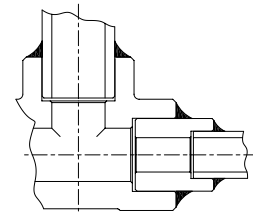

Applied View

### MSS SP-79

Class Designation of Fittings	Nominal Pipe Size	Type	Socket		Shank DIA. SD	Laying Length A	Bore D	Wall MIN. C	Length
			DIA. B	Depth Min. K					SL
6000	3/8 x 1/4	1	14.35	13	26.67	25	11.5	5.97	19
	1 x 1/2	1	21.97	13	33.40	28	11.5	5.97	21
	x 3/4	1	27.31	13	33.40	28	15.5	6.96	21
	1 1/4 x 1/2	2	21.97	13	42.16	22	11.5	5.97	-
	x 3/4	2	27.31	13	42.16	21	15.5	6.96	-
	x 1	1	34.04	13	42.16	30	20.5	7.92	22
	1 1/2 x 3/4	2	27.31	13	48.26	25	15.5	6.96	-
	x 1	1	34.04	13	48.26	29	20.5	7.92	25
	x 1 1/4	1	42.80	13	48.26	35	29.5	7.92	25
	2 x 1	2	34.04	13	60.32	25	21.0	7.92	-
	x 1 1/4	2	42.80	13	60.32	24	29.5	7.92	-
	x 1 1/2	1	48.90	13	60.32	39	34.0	8.90	28

All dimensions are in millimeters.



Union  
**SWUR**

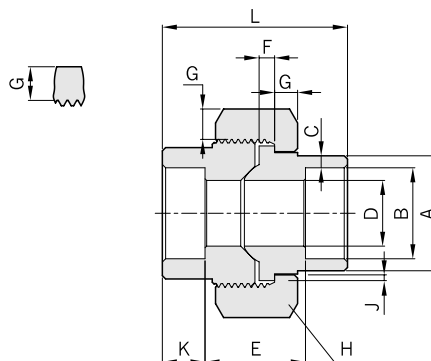
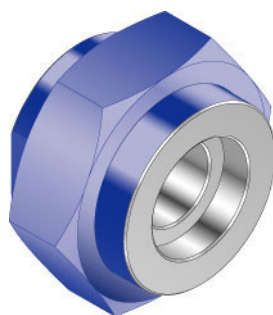

**MSS SP-83**

Nom. Pipe Size	DN	Pipe End Min.	Socket Bore Dia.	Socket Wall Min.	Water Way Bore	Laying Length	Male Flange Min.	Nut Min.	Bearing Min.	Depth of Socket Min.	Length Assem. Normal	Width Flats
		A	B	C	D	E	F	G	J	K	L	H
1/8	6	21.8	10.92 10.67	3.17	6.83 6.43	22.4 19.0	3.17	3.17	1.24	9.6	41.1	HEX. 30.0
1/4	8	21.8	14.22 13.97	3.30	9.85 9.45	22.4 19.0	3.17	3.17	1.24	9.6	41.4	HEX. 36.0
3/8	10	25.9	17.78 17.53	3.48	13.92 13.51	26.9 20.6	3.43	3.43	1.37	9.6	46.0	HEX. 41.0
1/2	15	31.2	21.84 21.59	4.06	17.47 17.07	26.9 20.6	3.68	3.68	1.50	9.6	49.0	HEX. 46.0
3/4	20	37.1	27.18 26.92	4.27	21.79 21.39	31.8 25.4	4.06	4.06	1.68	12.7	56.9	HEX. 55.0
1	25	45.5	34.04 33.78	4.95	28.14 27.74	34.3 26.2	4.57	4.44	1.85	12.7	62.0	HEX. 60.0
1 1/4	32	54.9	42.67 42.42	5.28	35.76 35.36	40.6 32.5	5.33	5.21	2.13	12.7	71.1	OCT. 75.0
1 1/2	40	61.5	48.77 48.51	5.54	41.61 41.20	42.2 34.0	5.84	5.59	2.31	12.7	76.5	OCT. 85.0
2	50	75.2	61.47 61.21	6.05	52.53 52.12	45.5 37.3	6.60	6.35	2.69	15.8	86.1	OCT. 94.0

All dimensions are in millimeters.

# Forged Fittings

## Socketlets SWOL

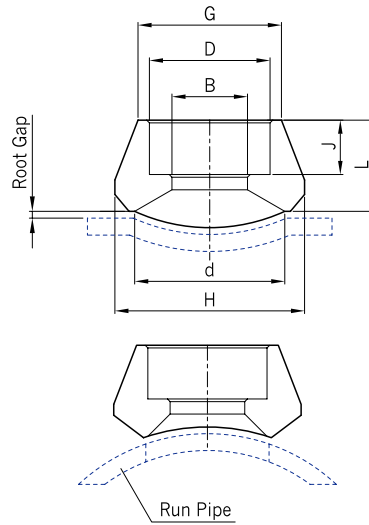
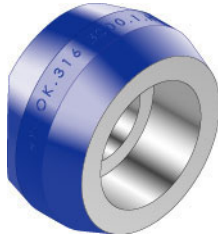

Class Designation of Fittings	Nom. Pipe Size	DN	B Socket Bore Dia. <sup>1)</sup>	D Bore Dia.	G	H	d	Depth of socket Min. J	L
3000	1/2	15	22.2 21.8	16.6 15.0	31.8	35.7	23.0	9.5	25.4
	3/4	20	27.6 27.2	21.7 20.2	36.6	43.7	29.4	12.5	26.9
	1	25	34.3 33.9	27.4 25.9	46.0	50.8	36.5	12.5	33.3
	1 1/4	32	43.1 42.7	35.8 34.3	55.6	65.1	44.5	12.5	33.3
	1 1/2	40	49.2 48.8	41.6 40.1	61.9	72.2	50.8	12.5	34.9
	2	50	61.7 61.2	53.3 51.7	74.6	88.1	65.1	16.0	39.1
6000	1/2	15	22.2 21.8	12.5 11.0	39.7	43.7	19.1	9.5	31.8
	3/4	20	27.6 27.2	16.3 14.8	45.2	49.6	25.4	12.5	36.6
	1	25	34.3 33.9	21.5 19.9	57.2	61.9	33.3	12.5	39.6
	1 1/4	32	43.1 42.7	30.2 28.7	65.1	69.1	38.1	12.5	41.3
	1 1/2	40	49.2 48.8	34.7 33.2	76.2	82.6	49.2	12.5	42.9
	2	50	61.7 61.2	43.6 42.1	92.1	102.4	69.9	16.0	52.3

Note : 1) Upper and lower values for each size are the respective maximum and minimum dimensions.  
 2) For the CL.3000 and 6000 socketlet, inside bore, socket depth dimensions are according to ASME B16.11  
 3) Pipe schedule numbers and weight designations are in accordance with ASME B36.10

All dimensions are in millimeters.

90° Elbow  
**SLA**

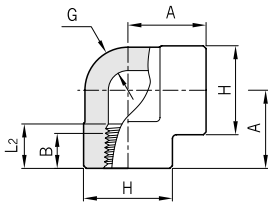

Tee  
**STA**

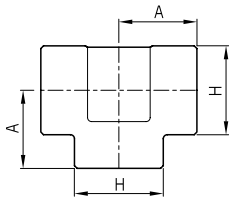

45° Elbow  
**SLB**

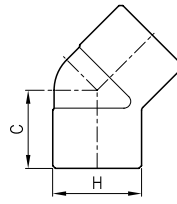

Cross  
**SXA**

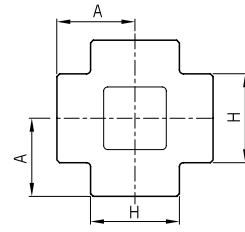
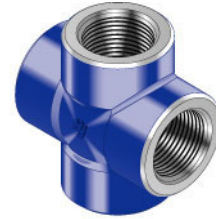

**ASME B16.11**

Class Designation of Fittings	Nom. Pipe Size	DN	Center to End Elbows, Tees Crosses A	Center to End 45° Elbows C	Outside Diameter of Band H	Min. Wall Thickness G	Min. Length of Thread <sup>(1)</sup>	
							B	L <sub>2</sub>
2000	1/8	6	21	17	22	3.18	6.4	6.7
	1/4	8	21	17	22	3.18	8.1	10.2
	3/8	10	25	19	25	3.18	9.1	10.4
	1/2	15	28	22	33	3.18	10.9	13.6
	3/4	20	33	25	38	3.18	12.7	13.9
	1	25	38	28	46	3.68	14.7	17.3
	1 1/4	32	44	33	56	3.89	17.0	18.0
	1 1/2	40	51	35	62	4.01	17.8	18.4
	2	50	60	43	75	4.27	19.0	19.2
	2 1/2	65	76	52	92	5.61	23.6	28.9
	3	80	86	64	109	5.99	25.9	30.5
4	100	106	79	146	6.55	27.7	33.0	

**Note :** (1) Dimension B is minimum length of perfect thread. The length of useful thread (B plus threads with fully formed roots and flat crests) shall not be less than L<sub>2</sub> (effective length of external thread) required by American National Standard for pipe threads (ASME B1.20.1)

All dimensions are in millimeters.

## Forged Fittings

90° Elbow  
**SLA**

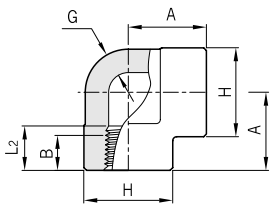

Tee  
**STA**

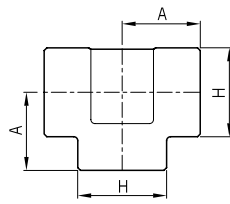

45° Elbow  
**SLB**

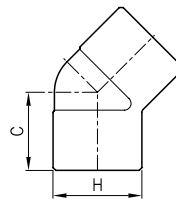

Cross  
**SXA**

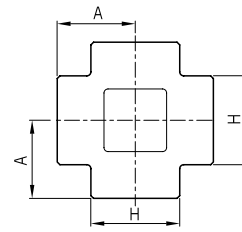
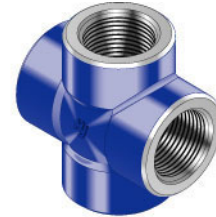

### ASME B16.11

Class Designation of Fittings	Nom. Pipe Size	DN	Center to End Elbows, Tees Crosses A	Center to End 45° Elbows C	Outside Diameter of Band H	Min. Wall Thickness G	Min.Length of Thread <sup>(1)</sup>	
							B	L <sub>2</sub>
3000	1/8	6	21	17	22	3.18	6.4	6.7
	1/4	8	25	19	25	3.30	8.1	10.2
	3/8	10	28	22	33	3.51	9.1	10.4
	1/2	15	33	25	38	4.09	10.9	13.6
	3/4	20	38	28	46	4.32	12.7	13.9
	1	25	44	33	56	4.98	14.7	17.3
	1 1/4	32	51	35	62	5.28	17.0	18.0
	1 1/2	40	60	43	75	5.56	17.8	18.4
	2	50	64	44	84	7.14	19.0	19.2
	2 1/2	65	83	52	102	7.65	23.6	28.9
	3	80	95	64	121	8.84	25.9	30.5
4	100	114	79	152	11.18	27.7	33.0	

**Note :** (1) Dimension B is minimum length of perfect thread. The length of useful thread (B plus threads with fully formed roots and flat crests) shall not be less than L<sub>2</sub> (effective length of external thread) required by American National Standard for pipe threads (ASME B1.20.1)

All dimensions are in millimeters.

90° Elbow  
**SLA**

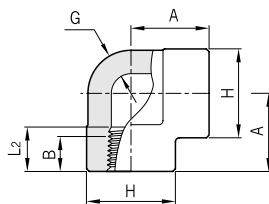

Tee  
**STA**

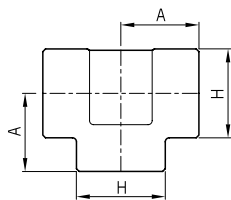

45° Elbow  
**SLB**

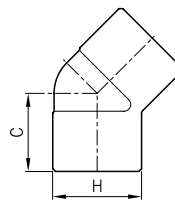

Cross  
**SXA**

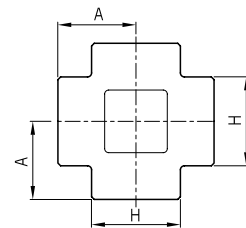
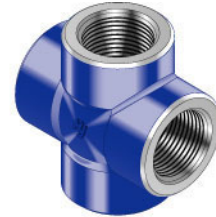

**ASME B16.11**

Class Designation of Fittings	Nom. Pipe Size	DN	Center to End Elbows, Tees Crosses A	Center to End 45° Elbows C	Outside Diameter of Band H	Min. Wall Thickness G	Min. Length of Thread <sup>(1)</sup>	
							B	L <sub>2</sub>
6000	1/8	6	25	19	25	6.35	6.4	6.7
	1/4	8	28	22	33	6.60	8.1	10.2
	3/8	10	33	25	38	6.98	9.1	10.4
	1/2	15	38	28	46	8.15	10.9	13.6
	3/4	20	44	33	56	8.53	12.7	13.9
	1	25	51	35	62	9.93	14.7	17.3
	1 1/4	32	60	43	75	10.59	17.0	18.0
	1 1/2	40	64	44	84	11.07	17.8	18.4
	2	50	83	52	102	12.09	19.0	19.2
	2 1/2	65	95	64	121	15.29	23.6	28.9
	3	80	106	79	146	16.64	25.9	30.5
4	100	114	79	152	18.67	27.7	33.0	

**Note:** (1) Dimension B is minimum length of perfect thread. The length of useful thread (B plus threads with fully formed roots and flat crests) shall not be less than L<sub>2</sub> (effective length of external thread) required by American National Standard for pipe threads (ASME B1.20.1)

All dimensions are in millimeters.

## Forged Fittings

### Street Elbows SLC

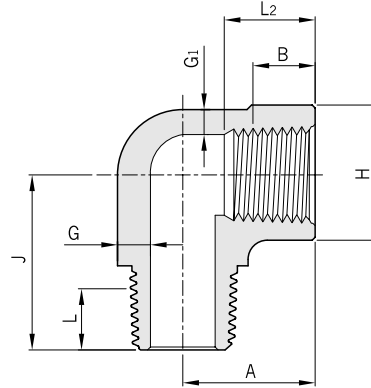

### ASME B16.11

Class Designation of Fittings	Nom. Pipe Size	DN	Center-to-Female End Street Ells A <sup>(1)</sup>	Center-to-Male End Street Ells J	Outside Diameter of Band H <sup>(2)</sup>	Min. Wall Thickness G <sub>1</sub>	Min. Wall Thickness G <sup>(3)</sup>	Min. Length Internal Thread <sup>(4)</sup>		Min. Length Male Thread L
								B	L <sub>2</sub>	
3000	1/8	6	19	25	19	3.18	2.74	6.4	6.7	10
	1/4	8	22	32	25	3.30	3.22	8.1	10.2	11
	3/8	10	25	38	32	3.51	3.50	9.1	10.4	13
	1/2	15	28	41	38	4.09	4.16	10.9	13.6	14
	3/4	20	35	48	44	4.32	4.88	12.7	13.9	16
	1	25	44	57	51	4.98	5.56	14.7	17.3	19
	1 1/4	32	51	66	62	5.28	5.56	17.0	18.0	21
	1 1/2	40	54	71	70	5.56	6.25	17.8	18.4	21
2	50	64	84	84	84	7.14	7.64	19.0	19.2	22

- Note :** (1) Dimension A listed on page 21 for the appropriate fitting size may also be used at the option of the manufacturer.  
 (2) Dimension H listed on page 21 for the appropriate fitting size may also be used at the option of the manufacturer.  
 (3) Wall thickness before threading.  
 (4) Dimension B is minimum length of perfect thread. The length of useful thread (B plus threads with fully formed roots and flat crests) shall not be less than L<sub>2</sub> (effective length of external thread) required by American National Standard for pipe threads (ASME B1.20.1)

All dimensions are in millimeters.

Street Elbows  
SLC

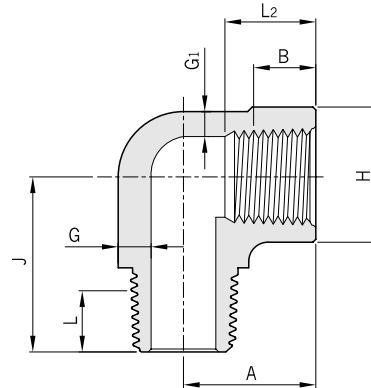

ASME B16.11

Class Designation of Fittings	Nom. Pipe Size	DN	Center-to-Female End Street Ells A <sup>(1)</sup>	Center-to-Male End Street Ells J	Outside Diameter of Band H <sup>(2)</sup>	Min. Wall Thickness G <sub>1</sub>	Min. Wall Thickness G <sup>(3)</sup>	Min. Length Internal Thread <sup>(4)</sup>		Min. Length Male Thread L
								B	L <sub>2</sub>	
6000	1/8	6	22	32	25	5.08	4.22	6.4	6.7	10
	1/4	8	25	38	32	5.66	5.28	8.1	10.2	11
	3/8	10	28	41	38	6.98	5.59	9.1	10.4	13
	1/2	15	35	48	44	8.15	6.53	10.9	13.6	14
	3/4	20	44	57	51	8.53	6.86	12.7	13.9	16
	1	25	51	66	62	9.93	7.95	14.7	17.3	19
	1 1/4	32	54	71	70	10.59	8.48	17.0	18.0	21
	1 1/2	40	64	84	84	11.07	8.89	17.8	18.4	21
2	50	83	105	102	12.09	9.70	19.0	19.2	22	

- Note :** (1) Dimension A listed on page 22 for the appropriate fitting size may also be used at the option of the manufacturer.  
 (2) Dimension H listed on page 22 for the appropriate fitting size may also be used at the option of the manufacturer.  
 (3) Wall thickness before threading.  
 (4) Dimension B is minimum length of perfect thread. The length of useful thread (B plus threads with fully formed roots and flat crests) shall not be less than L<sub>2</sub> (effective length of external thread) required by American National Standard for pipe threads (ASME B1.20.1)

All dimensions are in millimeters.

## Forged Fittings

### Full Coupling SFC

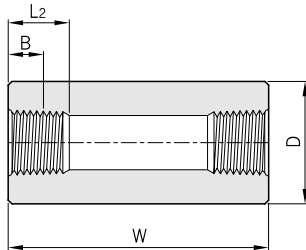

### Half Coupling SHC

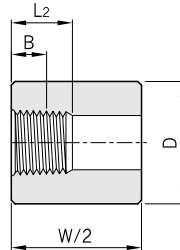

### Cap SCA

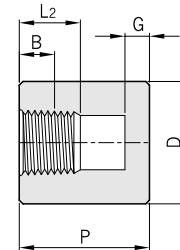

## ASME B16.11

Class Designation of Fittings	Nom. Pipe Size	DN	End-to-End Coupling W	End-to-End Coupling P	Outside Diameter D	End Wall Thickness Min. G	Min.Length of Thread <sup>(1)</sup>	
							B	L <sub>2</sub>
3000	1/8	6	32	19	16	4.8	6.4	6.7
	1/4	8	35	25	19	4.8	8.1	10.2
	3/8	10	38	25	22	4.8	9.1	10.4
	1/2	15	48	32	28	6.4	10.9	13.6
	3/4	20	51	37	35	6.4	12.7	13.9
	1	25	60	41	44	9.7	14.7	17.3
	1 1/4	32	67	44	57	9.7	17.0	18.0
	1 1/2	40	79	44	64	11.2	17.8	18.4
	2	50	86	48	76	12.7	19.0	19.2
	2 1/2	65	92	60	92	15.7	23.6	28.9
	3	80	108	65	108	19.0	25.9	30.5
	4	100	121	68	140	22.4	27.7	33.0

**General Note :** (A) Class 2000 and NPS 1/8 Class 6000 couplings, half couplings, and caps are not included in this standard.

(B) The wall thickness away from the threaded ends shall meet the minimum wall thickness requirements listed on page 21 for the appropriate NPS and Class Designation fitting.

**Note :** (1) Dimension B is minimum length of perfect thread. The length of useful thread(B plus threads with fully formed roots and flat crests) shall not be less than L<sub>2</sub> (effective length of external thread) required by American National Standard for pipe threads (ASME B1.20.1)

All dimensions are in millimeters.



Full Coupling  
**SFC**

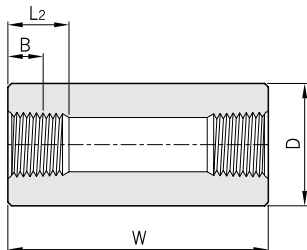

Half Coupling  
**SHC**

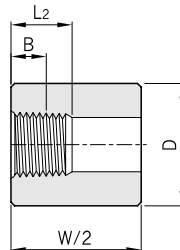

Cap  
**SCA**

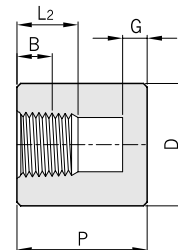

**ASME B16.11**

Class Designation of Fittings	Nom. Pipe Size	DN	End-to-End Coupling W	End-to-End Coupling P	Outside Diameter D	End Wall Thickness Min. G	Min.Length of Thread <sup>(1)</sup>	
							B	L <sub>2</sub>
6000	1/8	6	32	-	22	-	6.4	6.7
	1/4	8	35	27	25	6.4	8.1	10.2
	3/8	10	38	27	32	6.4	9.1	10.4
	1/2	15	48	33	38	7.9	10.9	13.6
	3/4	20	51	38	44	7.9	12.7	13.9
	1	25	60	43	57	11.2	14.7	17.3
	1 1/4	32	67	46	64	11.2	17.0	18.0
	1 1/2	40	79	48	76	12.7	17.8	18.4
	2	50	86	51	92	15.7	19.0	19.2
	2 1/2	65	92	64	108	19.0	23.6	28.9
	3	80	108	68	127	22.4	25.9	30.5
	4	100	121	75	159	28.4	27.7	33.0

**General Note :** (A) Class 2000 and NPS 1/8 Class 6000 couplings, half couplings, and caps are not included in this standard.

(B) The wall thickness away from the threaded ends shall meet the minimum wall thickness requirements listed on page 22 for the appropriate NPS and Class Designation fitting.

**Note :** (1) Dimension B is minimum length of perfect thread. The length of useful thread(B plus threads with fully formed roots and flat crests) shall not be less than L<sub>2</sub> (effective length of external thread) required by American National Standard for pipe threads (ASME B1.20.1)

All dimensions are in millimeters.

## Forged Fittings

### Boss Type A SBA

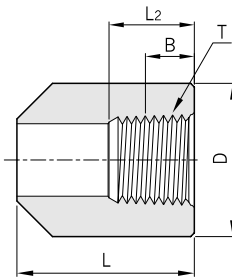

### Boss Type R SBR

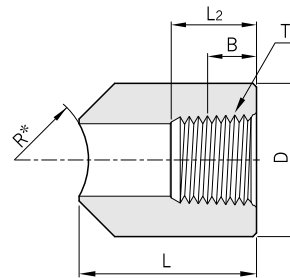

## ASME B16.11

Fittings Pressure Class	Nom. Pipe Size	DN	Outside Diameter D	L	Min. Length of Thread <sup>(1)</sup>	
					B	L <sub>2</sub>
3000	1/4	8	19	40	8.1	10.2
	3/8	10	22	40	9.1	10.4
	1/2	15	28	50	10.9	13.6
	3/4	20	35	50	12.7	13.9
	1	25	44	50	14.7	17.3
	1 1/4	32	57	50	17.0	18.0
	1 1/2	40	64	50	17.8	18.4
	2	50	76	60	19.0	19.2
6000	1/2	15	38	50	10.9	13.6
	3/4	20	44	50	12.7	13.9
	1	25	57	50	14.7	17.3
	1 1/4	32	64	50	17.0	18.0
	1 1/2	40	76	60	17.8	18.4
	2	50	92	60	19.0	19.2

Note : \* is run pipe sizes

Example : SBR06N-3000-R34 / S316 - 3/4" NPS CL3000 Run pipe 34.0mmO.D

(1) Dimension B is minimum length of perfect thread. The length of useful thread (B plus threads with fully formed roots and flat crests) shall not be less than L<sub>2</sub> (effective length of external thread) required by American national standard for pipe threads (ASME B1.20.1)

All dimensions are in millimeters.

Square Head Plug  
**H-SPD**

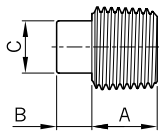

Hex Head Plug  
**H-SPB**

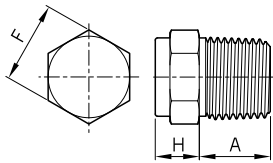
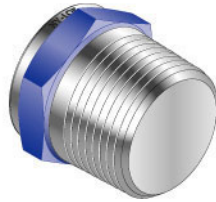

Round Head Plug  
**H-SPR**

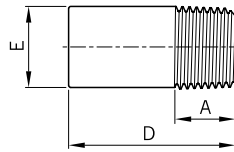

Hex Head Bushing  
**H-SHB**

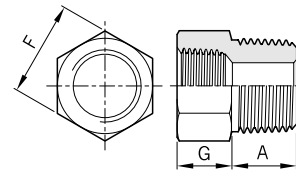
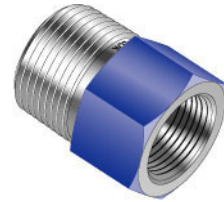

**ASME B 16.11**

Nom. Pipe Size	Min. Length A	Square Head Plugs		Round Head Plugs		Hex Plugs and Bushings		
		Min. Square Height B	Min. Width Flats C	Nom. Head Diameter E	Min. Length D	Nom. Width Flats F	Hex Height	
							Min. Bushing G	Plug H
1/8	10	6	7	10	35	11	-	6
1/4	11	6	10	14	41	16	3	6
3/8	13	8	11	18	41	18	4	8
1/2	14	10	14	21	44	22	5	8
3/4	16	11	16	27	44	27	6	10
1	19	13	21	33	51	36	6	10
1 1/4	21	14	24	43	51	46	7	14
1 1/2	21	16	28	48	15	50	8	16
2	22	18	32	60	64	65	9	18
2 1/2	27	19	36	73	70	75	10	19
3	28	21	41	89	70	90	10	21
4	32	25	65	114	76	115	13	25

**Note :** Cautionary Note Regarding Hex Bushing : Hex head bushings of one-size reduction should not be used in services where they might be subject to harmful loads and forces other than internal pressures.

All dimensions are in millimeters.

## Forged Fittings

### Union SUR

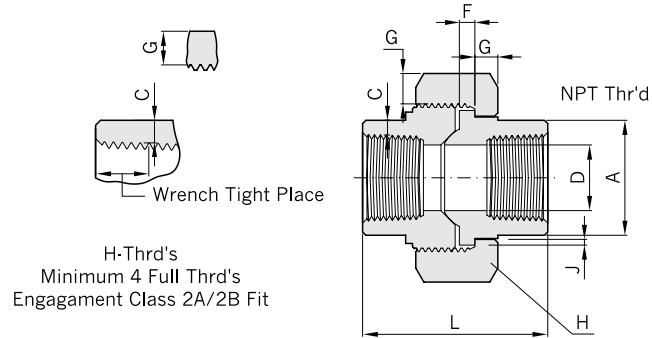
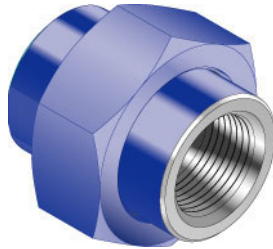

### MSS SP-83

Nom. Pipe Size	DN	Pipe End Min.	Socket Wall Min.	Water Way Bore	Male Flange Min.	Nut Min.	Bearing Min.	Length Assem. Normal	Width Flats
		A	C	D	F	G	J	L	H
1/8	6	21.8	3.17	6.83 6.43	3.17	3.17	1.24	41.4	HEX. 30.0
1/4	8	21.8	3.30	9.85 9.45	3.17	3.17	1.24	41.4	HEX. 36.0
3/8	10	25.9	3.48	13.92 13.51	3.43	3.43	1.37	46.0	HEX. 41.0
1/2	15	31.2	4.06	17.47 17.07	3.68	3.68	1.50	49.0	HEX. 46.0
3/4	20	37.1	4.27	21.79 21.39	4.06	4.06	1.68	56.9	HEX. 55.0
1	25	45.5	4.95	28.14 27.74	4.57	4.44	1.85	62.0	HEX. 60.0
1 1/4	32	54.9	5.28	35.76 35.36	5.33	5.21	2.13	71.1	OCT. 75.0
1 1/2	40	61.5	5.54	41.61 41.20	5.84	5.59	2.31	76.5	OCT. 85.0
2	50	75.2	6.05	52.53 52.12	6.60	6.35	2.69	86.1	OCT. 94.0

All dimensions are in millimeters.

Nipple Outlet  
**SNOL**

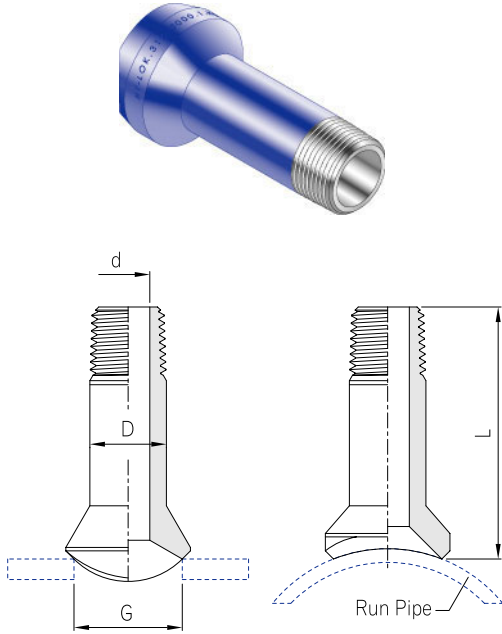

Nom. Pipe Size	DN	Run Pipe Size	L	G	d	D
1/2	15	36~ 3/4	88.9	23.9	14.0	21.3
3/4	20	36~ 1	88.9	30.2	18.8	26.7
1	25	36~1 1/4	88.9	36.6	24.4	33.3
1 1/4	32	36~1 1/2	88.9	44.5	32.5	42.2
1 1/2	40	36~ 2	88.9	50.8	38.1	48.3
2	50	36~2 1/2	88.9	65.0	49.3	60.5

Plain Nipple Outlet  
**SPOL**

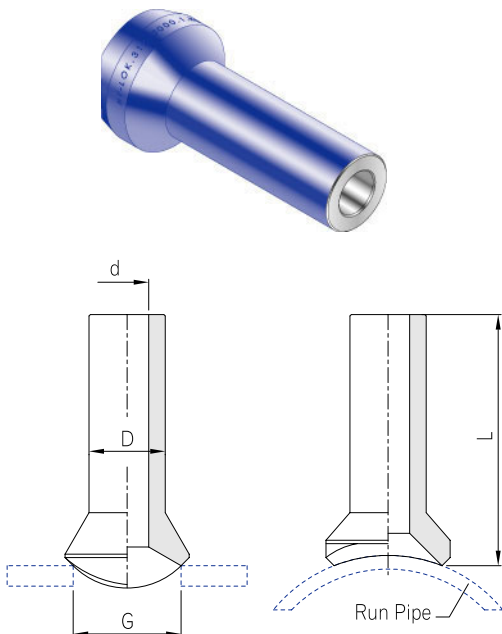

Nom. Pipe Size	DN	Run Pipe Size	L	G	d	D
1/2	15	36~3/4	88.9	23.9	14.0	21.3
3/4	20	36~ 1	88.9	30.2	18.8	26.7
1	25	36~1 1/4	88.9	36.6	24.4	33.3
1 1/4	32	36~1 1/2	88.9	44.5	32.5	42.2
1 1/2	40	36~ 2	88.9	50.8	38.1	48.3
2	50	36~2 1/2	88.9	65.0	49.3	60.5

Note : XX is Run Pipe Sizes

All dimensions are in millimeters.

# Forged Fittings

## Swaged Nipple

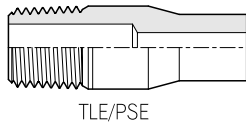
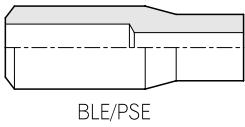
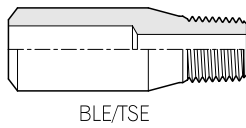
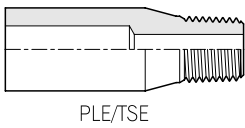
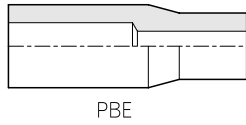
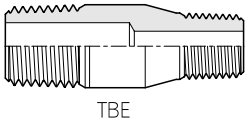

### MSS-SP-95

Large end Size	Small end Size	Length
1/2	3/8 - 1/8	70
3/4	1/2 - 1/8	76
1	3/4 - 1/8	89
1 1/4	1 - 1/8	102
1 1/2	1 1/4 - 1/8	114
2	1 1/2 - 1/8	165
2 1/2	2 - 1/8	178
3	2 1/2 - 1/8	203
3 1/2	3 - 1/8	203
4	3 1/2 - 1/8	229

TBE : Thread both end  
 PBE : Plain both end  
 PLE/TSE : Plain large end - thread small end  
 BLE/TSE : Beveled large end - Thread small end  
 BLE/PSE : Beveled large end - Plain small end  
 TLE/PSE : Thread large end - Plain small end

All dimensions are in millimeters.

Thredolets  
**SOL**

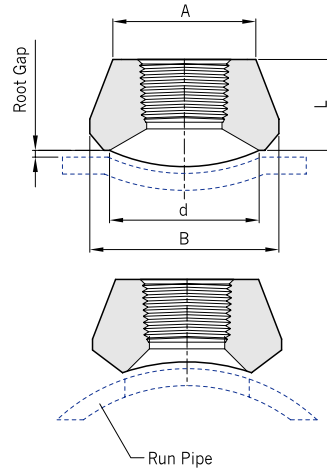

Class Designation of Fittings	Nom. Pipe Size	A	B	d	L
3000	1/2	31.8	35.7	23.8	25.4
	3/4	36.6	43.7	29.4	26.9
	1	46.0	50.8	36.5	33.3
	1 1/4	55.6	65.1	44.5	33.3
	1 1/2	61.9	72.2	50.8	34.9
	2	74.6	88.1	65.1	38.1
6000	1/2	39.7	43.7	19.1	31.8
	3/4	45.2	49.6	25.4	36.6
	1	57.2	61.9	33.3	39.6
	1 1/4	65.1	69.1	38.1	41.3
	1 1/2	76.2	82.6	49.2	42.9
	2	92.1	102.4	69.9	52.3

**Note :** • For the CL.3000 and 6000 thredolets , inside bore, thread length dimensions are according to ASME B16.11  
 • Pipe schedule numbers and weight designations are in accordance with ASME B36.10

All dimensions are in millimeters.

## Forged Fittings

### Hex Nipple H-SNA

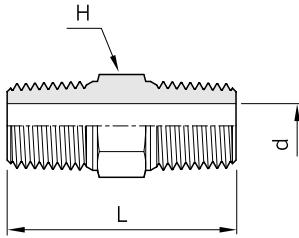

Nom. Pipe Size	L	d	H Width Across Flat
1/8	25.4	4.8	11.1
1/4	35.3	7.1	14.2
3/8	36.1	9.6	17.4
1/2	46.7	11.9	22.2
3/4	46.7	15.7	26.9
1	58.7	22.3	34.9
1 1/4	61.2	27.7	44.4
1 1/2	67.3	34.0	50.0
2	73.7	46.0	65.0

### Hex Reducing Nipple H-SNR

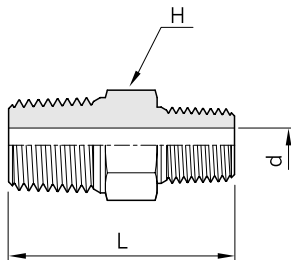
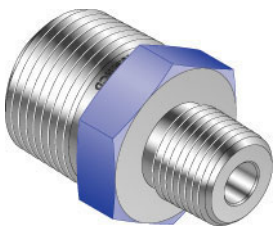

Nom. Pipe Size	Reduced Nom. Pipe Size	L	d	H Width Across Flat
1/4	1/8	30.7	4.8	14.2
3/8	1/8	32.0	4.8	17.4
3/8	1/4	36.1	7.1	17.4
1/2	1/8	37.2	4.8	22.2
1/2	1/4	41.7	7.1	22.2
1/2	3/8	41.7	9.6	22.2
3/4	1/4	41.7	7.1	26.9
3/4	1/2	46.7	11.9	26.9
1	1/4	49.3	7.1	34.9
1	1/2	54.1	11.9	34.9
1 1/4	1	61.2	22.3	44.4
1 1/2	1	65.8	22.3	50.0
2	1	71.6	22.3	70.0

All dimensions are in millimeters.



Hollow Hex Plug  
**H-SPA**

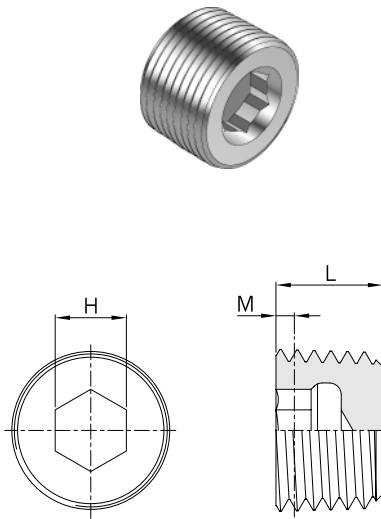

Nom. Pipe Size	H (HEX.)	L	M
1/8	5	7.0	0.45
1/4	6	9.0	0.70
3/8	8	10.0	0.70
1/2	10	12.0	0.90
3/4	14	14.0	0.90
1	17	16.5	1.10
1 1/4	22	19.0	1.10
1 1/2	22	20.0	1.10
2	27	22.0	1.10

Hex Head Plug  
**H-SPC**

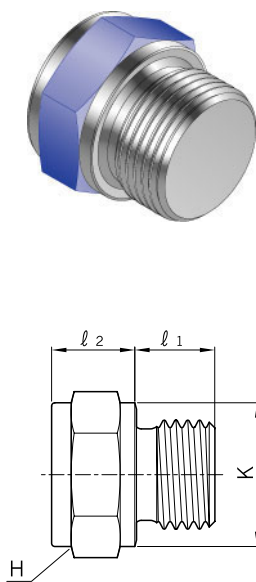

ISO Parallel Thread	l <sub>1</sub>	l <sub>2</sub>	K	H (HEX.)
1/8	7.1	11.5	13.8	14.0
1/4	11.2	12.9	18.0	19.0
3/8	11.2	13.8	22.0	22.0
1/2	14.2	16.3	26.0	27.0
3/4	15.7	14.8	32.0	33.3
1	18.3	19.8	39.0	41.0

All dimensions are in millimeters.

## Blanking Plugs with \*ED-Ring for Ports DVSTI-GED/MED

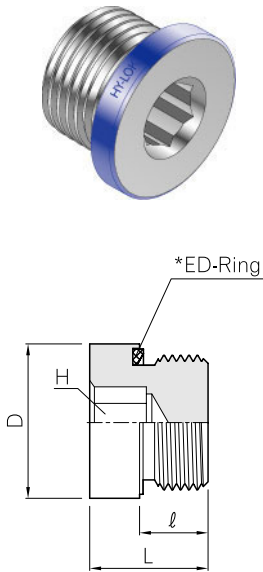

ISO Metric Thread	ISO Parallel Thread	D	H	L	l
M 10 x 1	1/8	14.0	5	12.0	8
M 12 x 1.5	-	17.0	6	17.0	12
M 14 x 1.5	1/4	19.0	6	17.0	12
M 16 x 1.5	3/8	22.0	8	17.0	12
M 18 x 1.5	-	23.9	8	17.0	12
M 20 x 1.5	-	25.9	10	19.0	14
M 22 x 1.5	1/2	27.0	10	19.0	14
M 26 x 1.5	-	31.9	12	21.0	16
M 27 x 2	3/4	32.0	12	21.0	16
M 33 x 2	1	39.9	17	22.5	16
M 42 x 2	1 1/4	49.9	22	22.5	16
M 48 x 2	1 1/2	55.0	24	22.5	16

## Blanking Plugs with \*O-Ring for Ports acc. to ISO 6149 / DIN3852 DVSTI

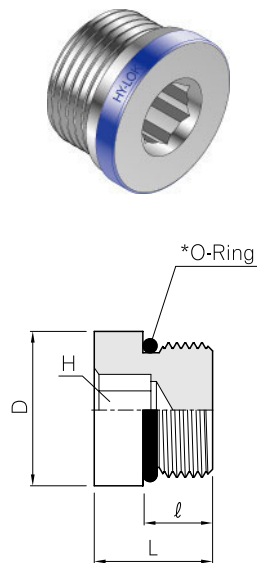

ISO Metric Thread	D	H	L	l
M 10 x 1	13	5	14.0	10.0
M 12 x 1.5	17	6	16.5	11.5
M 14 x 1.5	19	6	16.5	11.5
M 16 x 1.5	21	6	18.0	13.0
M 18 x 1.5	23	8	19.5	14.5
M 22 x 1.5	27	10	20.5	15.5
M 26 x 1.5	31	12	21.0	16.0
M 27 x 2	32	12	24.0	19.0
M 33 x 2	38	17	25.5	19.0
M 42 x 2	48	22	26.0	19.5

All dimensions are in millimeters.

\* The Standard ED-Ring, O-Ring material is NBR(e.g. Perbunan®) however FPM(e.g. Viton®) is also available on request

# Seal & Condensate Pot

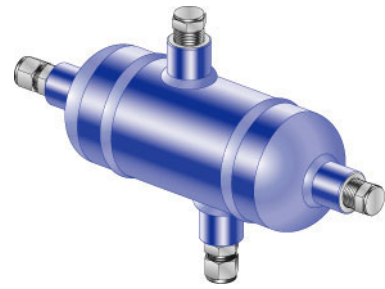
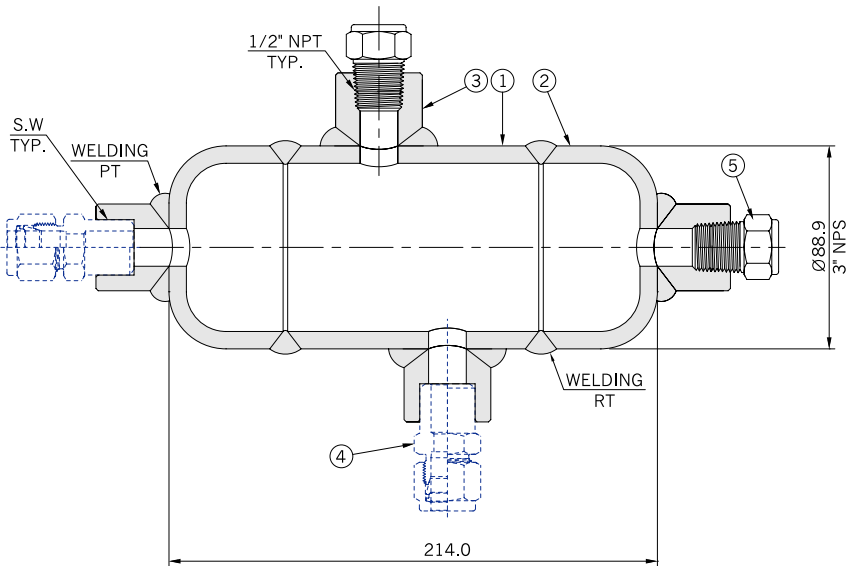

## Materials of Constructions

No.	Description	Materials
1	3" Pipe	Refer. to below
2	3" Cap	Refer. to below
3	Half Coupling	SS316 or C.S
4	Weld Connector	SS316
5	Hex. Plug	SS316 or C.S

This drawing is standard specification for part no. ACSPF4NTB

## Part Number Designation

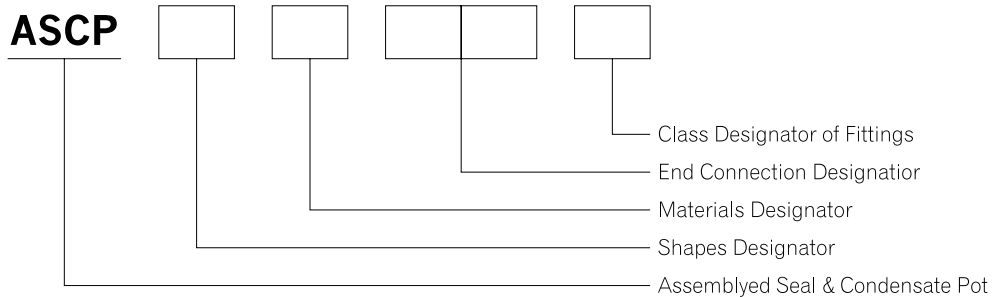

### Shapes Designator

Shapes	Identifier
	A
	B
	C
	D
	E
	F

### Materials Designator

Materials	Identifier
A335 Gr. P11	1
A335 Gr. P22	2
A106 Gr. B	3
A312 Gr. TP304	4
A312 Gr. TP316	5
A312 Gr. TP304L	6
A312 Gr. TP316L	7

### End Connection Designator

Connection	Identifier
1/2 NPT	N
1/2 PT	R
1/2 S.W	W
1/2" Hy-Lok	T

### Class Designator of Fittings

Schedule No.	Identifier
SCH 40	A
SCH 80	B
SCH 160	C
SCH XXS.	D

All dimensions are in millimeters.

## Forged Fittings

# Dimensions of Welded and Seamless Pipe Carbon, Alloy and Stainless Steel

### ASME B36.10M, B36.19M

(in millimeters)

Nominal Pipe Size (in inches)	Outside Diameter	Nominal Wall Thickness								
		Sch 5S	Sch 10S	Sch 10	Sch 20	Sch 30	Sch 40S	STD	Sch 40	Sch 60
1/8	10.29	-	1.24	-	-	-	1.73	1.73	1.73	-
1/4	13.72	-	1.65	-	-	-	1.73	1.73	2.24	-
3/8	17.14	-	1.65	-	-	-	2.31	2.31	2.31	-
1/2	21.34	1.65	2.11	-	-	-	2.77	2.77	2.77	-
3/4	26.67	1.65	2.11	2.11	-	-	2.87	2.87	2.87	-
1	33.40	1.65	2.77	2.77	-	-	3.38	3.38	3.38	-
1 1/4	42.16	1.65	2.77	2.77	-	-	3.56	3.56	3.56	-
1 1/2	48.26	1.65	2.77	2.77	-	-	3.68	3.68	3.68	-
2	60.32	1.65	2.77	2.77	-	-	3.91	3.91	3.91	-
2 1/2	73.02	2.11	3.05	3.05	-	-	5.16	5.16	5.16	-
3	88.90	2.11	3.05	3.05	-	-	5.49	5.49	5.49	-
3 1/2	101.60	2.11	3.05	3.05	-	-	5.74	5.74	5.74	-
4	114.30	2.11	3.05	3.05	-	-	6.02	6.02	6.02	-
5	141.30	2.77	3.40	3.40	-	-	6.55	6.55	6.55	-
6	168.28	2.77	3.40	-	-	-	7.11	7.11	7.11	-
8	219.08	2.77	3.76	-	6.35	7.04	8.18	8.18	8.18	10.31
10	273.05	3.40	4.19	-	6.35	7.80	9.27	9.27	9.27	12.70
12	323.85	3.96	4.57	-	6.35	8.38	9.52	9.52	10.31	14.27
14	355.60	3.96	4.78	6.35	7.92	9.52	-	9.52	11.13	15.06
16	406.40	4.19	4.78	6.35	7.92	9.52	-	9.52	12.70	16.66
18	457.20	4.19	4.78	6.35	7.92	11.12	-	9.52	14.27	19.05
20	508.00	4.78	5.54	6.35	9.52	12.70	-	9.52	15.06	20.62
22	588.80	4.78	5.54	6.35	9.52	12.70	-	9.52	15.87	22.22
24	609.60	5.54	6.35	6.35	9.52	14.27	-	9.52	17.48	24.61
26	660.40	-	-	7.92	12.70	-	-	9.52	-	-
28	711.20	-	-	7.92	12.70	15.88	-	9.52	-	-
30	762.00	6.35	7.92	7.92	12.70	15.88	-	9.52	-	-
32	812.80	-	-	7.92	12.70	15.88	-	9.52	17.48	-
34	863.60	-	-	7.92	12.70	15.88	-	9.52	17.48	-
36	914.40	-	-	7.92	12.70	15.88	-	9.52	19.05	-
38	965.20	-	-	-	-	-	-	9.52	-	-
40	1016.00	-	-	-	-	-	-	9.52	-	-
42	1066.80	-	-	-	-	-	-	9.52	-	-
44	1117.60	-	-	-	-	-	-	9.52	-	-
46	1168.40	-	-	-	-	-	-	9.52	-	-
48	1219.20	-	-	-	-	-	-	9.52	-	-

## ASME B36.10M, B36.19M

(in millimeters)

Nominal Wall Thickness								Outside Diameter	Nominal Pipe Size (in inches)
Sch 80S	XS	Sch 80	Sch 100	Sch 120	Sch 140	Sch 160	XXS		
2.41	2.41	2.41	-	-	-	-	-	10.29	1/8
3.02	3.02	3.02	-	-	-	-	-	13.72	1/4
3.20	3.20	3.20	-	-	-	-	-	17.14	3/8
3.73	3.73	3.73	-	-	-	4.75	7.47	21.34	1/2
3.91	3.91	3.91	-	-	-	5.54	7.82	26.67	3/4
4.55	4.55	4.55	-	-	-	6.35	9.09	33.40	1
4.85	4.85	4.85	-	-	-	6.35	9.70	42.16	1 1/4
5.08	5.08	5.08	-	-	-	7.14	10.16	48.26	1 1/2
5.54	5.54	5.54	-	-	-	8.71	11.07	60.32	2
7.01	7.01	7.01	-	-	-	9.52	14.02	73.02	2 1/2
7.62	7.62	7.62	-	-	-	11.13	15.24	88.90	3
8.08	8.08	8.08	-	-	-	-	16.15	101.60	3 1/2
8.56	8.56	8.56	-	11.13	-	13.49	17.12	114.30	4
9.53	9.53	9.53	-	12.70	-	15.88	19.05	141.30	5
10.97	10.97	10.97	-	14.27	-	18.24	21.95	168.28	6
12.70	12.70	12.70	15.06	18.26	20.62	23.01	22.22	219.08	8
12.70	12.70	15.06	18.26	21.44	25.40	28.58	25.40	273.05	10
12.70	12.70	17.48	21.44	25.40	28.58	33.32	25.40	323.85	12
	12.70	19.05	23.83	27.79	31.75	35.71	-	355.60	14
	12.70	21.44	26.19	30.96	36.52	40.46	-	406.40	16
	12.70	23.82	29.36	34.92	39.67	45.24	-	457.20	18
	12.70	26.19	32.54	38.10	44.45	49.99	-	508.00	20
	12.70	28.58	34.92	41.28	47.62	53.98	-	558.80	22
	12.70	30.93	38.89	46.02	52.37	59.51	-	609.60	24
	12.70	-	-	-	-	-	-	660.40	26
	12.70	-	-	-	-	-	-	711.20	28
	12.70	-	-	-	-	-	-	762.00	30
	12.70	-	-	-	-	-	-	812.80	32
	12.70	-	-	-	-	-	-	863.60	34
	12.70	-	-	-	-	-	-	914.40	36
	12.70	-	-	-	-	-	-	965.20	38
	12.70	-	-	-	-	-	-	1016.00	40
	12.70	-	-	-	-	-	-	1066.80	42
	12.70	-	-	-	-	-	-	1117.60	44
	12.70	-	-	-	-	-	-	1168.40	46
	12.70	-	-	-	-	-	-	1219.20	48

Dimensions are in millimeters.

# American National Standard Taper Pipe Threads : NPT (ANSI : B1.20.1)

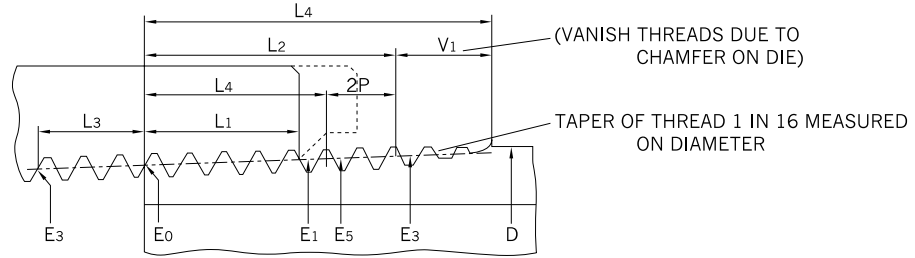

Nominal Pipe Size	Outside Dia. of Pipe D	Threads per Inch n	Pitch of Thread P	Pitch Diameter at Beginning of External Thread E <sub>0</sub>	Handtight Engagement		Effective Thread External	
					Length L <sub>1</sub>	Dia. E <sub>1</sub>	Length L <sub>2</sub>	Dia. E <sub>2</sub>
1/16	0.3125	27	0.03704	0.27118	0.1600	0.28118	0.2611	0.28750
1/8	0.4050	27	0.03704	0.36351	0.1615	0.37360	0.2639	0.38000
1/4	0.5400	18	0.05556	0.47739	0.2278	0.49163	0.4018	0.50250
3/8	0.6750	18	0.05556	0.61201	0.2400	0.62701	0.4078	0.63750
1/2	0.8400	14	0.07143	0.75843	0.3200	0.77843	0.5337	0.79179
3/4	1.0500	14	0.07143	0.96768	0.3390	0.98887	0.5457	1.00179
1	1.3150	11 1/2	0.08696	1.21363	0.4000	1.23863	0.6828	1.25630
1 1/4	1.6600	11 1/2	0.08696	1.55713	0.4200	1.58338	0.7068	1.60130
1 1/2	1.9000	11 1/2	0.08696	1.79609	0.4200	1.82234	0.7235	1.84130
2	2.3750	11 1/2	0.08696	2.26902	0.4360	2.29627	0.7565	2.31630
2 1/2	2.8750	8	0.12500	2.71953	0.6820	2.76216	1.1375	2.79062
3	3.5000	8	0.12500	3.34062	0.7660	3.38850	1.2000	3.41562
3 1/2	4.0000	8	0.12500	3.83750	0.8210	3.88881	1.2500	3.91562
4	4.5000	8	0.12500	4.33438	0.8440	4.38712	1.3000	4.41562
5	5.5630	8	0.12500	5.39073	0.9370	5.44929	1.4063	5.47862
6	6.6250	8	0.12500	6.44609	0.9580	6.50597	1.5125	6.54062

Nominal Pipe Size	Wrench Make - up Length for External Thread L <sub>2</sub> - L <sub>1</sub>	Wrench Make - up Length for Internal Thread		Vanish Thread, (3.47 Thds) V	Overall Length External Thread L <sub>4</sub>	Nominal Perfect External Threads		Height of Thread h	Basic Minor Dia. at Small End of Pipe K <sub>0</sub>
		Length L <sub>3</sub>	Dia. E <sub>3</sub>			Length L <sub>5</sub>	Dia. E <sub>5</sub>		
1/16	0.1011	0.1111	0.26424	0.1285	0.3896	0.1870	0.28287	0.02963	0.2416
1/8	0.1024	0.1111	0.35656	0.1285	0.3924	0.1898	0.37537	0.02963	0.3339
1/4	0.1740	0.1667	0.46697	0.1928	0.5946	0.2907	0.49556	0.04444	0.4329
3/8	0.1678	0.1667	0.60160	0.1928	0.6006	0.2967	0.63056	0.04444	0.5676
1/2	0.2137	0.2143	0.74504	0.2478	0.7815	0.3909	0.78286	0.05714	0.7013
3/4	0.2067	0.2143	0.95429	0.2478	0.7935	0.4029	0.99286	0.05714	0.9105
1	0.2828	0.2609	1.19733	0.3017	0.9845	0.5089	1.24543	0.06957	1.1441
1 1/4	0.2868	0.2609	1.54083	0.3017	1.0085	0.5329	1.59043	0.06957	1.4876
1 1/2	0.3035	0.2609	1.77978	0.3017	1.0252	0.5496	1.83043	0.06957	1.7265
2	0.3205	0.2609	2.25272	0.3017	1.0582	0.5826	2.30543	0.06957	2.1995
2 1/2	0.4555	0.2500	2.70391	0.4337	1.5712	0.8875	2.77500	0.10000	2.6195
3	0.4340	0.2500	3.32500	0.4337	1.6337	0.9500	3.40000	0.10000	3.2406
3 1/2	0.4290	0.2500	3.82188	0.4337	1.6837	1.0000	3.90000	0.10000	3.7375
4	0.4560	0.2500	4.31875	0.4337	1.7337	1.0500	4.40000	0.10000	4.2344
5	0.4693	0.2500	5.37511	0.4337	1.8400	1.1563	5.46300	0.10000	5.2907
6	0.5545	0.2500	6.43047	0.4337	1.9462	1.2625	6.52500	0.10000	6.3461

# Taper Pipe Threads (JIS B0203 / B0202)

Basic profile of External Taper Thread and Internal Taper Thread

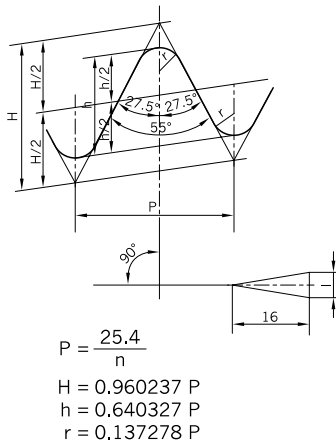

Basic profile of Internal Parallel Thread

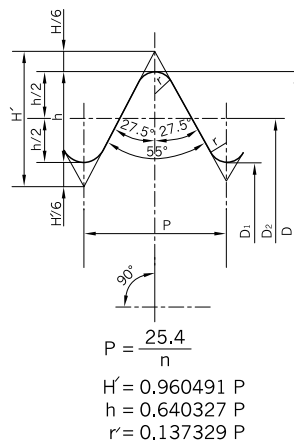

Fit of External Taper Thread to Internal Taper Thread or Internal Parallel Thread

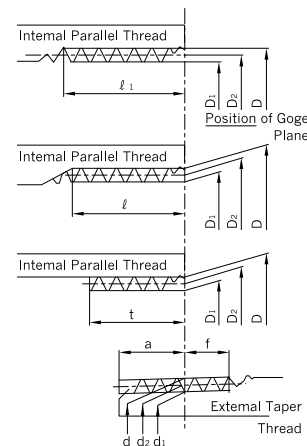

Nominal Size	Screw Thread				Basic Diameter			Position of Basic Diameter			Tolerance on Basic Diameters of Internal Parallel Thread	Effective Thread Length (Min.)				Nominal Pipe Size (For Reference)			
	Number of Thread per Inch	Pitch	Height of Thread	Round-ing	External Thread			External Thread		Internal Thread		Fitting Allowance	Internal Thread					Outside Diameter	Wall thickness
					Major Diameter d	Pitch Diameter d <sub>2</sub>	Minor Diameter d <sub>1</sub>	From the End of Pipe		The End of Pipe			When there is an Incomplete thread or More	When there is an Incomplete Thread					
								Basic Length	Tolerance Axially	Tolerance Axially					Internal Taper Thread	Internal Parallel Thread	Internal Taper and Parallel Thread		
					Internal Thread			Basic Length	Tolerance Axially	Tolerance Axially			Internal Taper Thread	Internal Parallel Thread	Internal Taper and Parallel Thread				
Major Diameter	Pitch Diameter	Minor Diameter																	
n	p	h	r	D	D <sub>2</sub>	D <sub>1</sub>	a	±b	±c	±	f	ℓ	ℓ <sub>1</sub>	t					
R(PT) 1/8	28	0.9071	0.581	0.12	9.728	9.147	8.566	3.97	0.91	1.13	0.071	2.5	6.2	7.4	4.4	10.5	2.0		
R(PT) 1/4	19	1.3368	0.856	0.18	13.157	12.301	11.445	6.01	1.34	1.67	0.104	3.7	9.4	11.0	6.7	13.8	2.3		
R(PT) 3/8	19	1.3368	0.856	0.18	16.662	15.806	14.950	6.35	1.34	1.67	0.104	3.7	9.7	11.4	7.0	17.3	2.3		
R(PT) 1/2	14	1.8143	1.162	0.25	20.955	19.793	18.631	8.16	1.81	2.27	0.142	5.0	12.7	15.0	9.1	21.7	2.8		
R(PT) 3/4	14	1.8143	1.162	0.25	26.441	25.279	24.117	9.53	1.81	2.27	0.142	5.0	14.1	16.3	10.2	27.2	2.8		
R(PT) 1	11	2.3091	1.479	0.32	33.249	31.770	30.291	10.39	2.31	2.89	0.181	6.4	16.2	19.1	11.6	34.0	3.2		
R(PT) 1 1/4	11	2.3091	1.479	0.32	41.910	40.431	38.952	12.70	2.31	2.89	0.181	6.4	18.5	21.4	13.4	42.7	3.5		
R(PT) 1 1/2	11	2.3091	1.479	0.32	47.803	46.324	44.845	12.70	2.31	2.89	0.181	6.4	18.5	21.4	13.4	48.6	3.5		
R(PT) 2	11	2.3091	1.479	0.32	59.614	58.135	56.656	15.88	2.31	2.89	0.181	7.5	22.8	25.7	16.9	60.5	3.8		
R(PT) 2 1/2	11	2.3091	1.479	0.32	75.184	73.705	72.226	17.46	3.46	3.46	0.216	9.2	26.7	30.1	18.6	76.3	4.2		
R(PT) 3	11	2.3091	1.479	0.32	87.884	86.405	84.926	20.64	3.46	3.46	0.216	9.2	29.8	33.3	21.1	89.1	4.2		
R(PT) 3 1/2	11	2.3091	1.479	0.32	100.330	98.851	97.372	22.23	3.46	3.46	0.216	9.2	31.4	34.9	22.4	101.6	4.2		
R(PT) 4	11	2.3091	1.479	0.32	113.030	111.551	110.072	25.40	3.46	3.46	0.216	10.4	35.8	39.3	25.9	114.3	4.5		
R(PT) 5	11	2.3091	1.479	0.32	138.430	136.951	135.472	28.58	3.46	3.46	0.216	11.5	40.1	43.5	29.3	139.8	4.5		
R(PT) 6	11	2.3091	1.479	0.32	163.830	162.351	160.872	28.58	3.46	3.46	0.216	11.5	40.1	43.5	29.4	165.2	5.0		



Distributed by :